

Viega Metal Systems



Installation Manual



Viega Metal Systems: The complete system

This guide is designed to provide you with installation guidelines for Viega Metallic Systems including:

ProPress® Copper and Bronze fittings

ProPress® Stainless pipe and fittings

Seapress Copper-Nickel-Iron fittings

Sanpress INOX Stainless Metric pipe and fittings

Profipress Copper metric fittings

System function and safety can only be guaranteed as a complete system if Viega components are used exclusively. Safety and precision systems are of the utmost importance to Viega and its distributors.



Viega produces over 1 million fittings a day and manufactures over 12,000 products in our headquarters in Attendorn and at our other manufacturing facilities in Lennestadt-Elspe, Attendorn-Ennest and Grossheringen, Germany and McPherson, Kansas, USA.

For current revisions, see Viega's website at www.viega.com

Viega IM-MTL 0110
724607

An international company with a national commitment

For 110 years, Viega has been a trusted name in the piping and tubing system manufacturing business. We research, develop and produce complete system solutions for contractors in the plumbing, industrial, shipbuilding, radiant heating and snow melting installation business. Each of our systems is developed in-house and tested under stringent quality control conditions to guarantee safe and efficient operation. Through innovative techniques and sophisticated technologies Viega has become the worldwide industry leader.

Today, Viega products extend worldwide. Our network of sales experts and wholesale distributors can meet your needs. The products we deliver are of the finest quality, offered at a competitive price. Our goal is to remain in the forefront of the plumbing industry.

Call 1-800-976-9819 for your local District Manager and wholesale location.

Welcome

By choosing a Viega System, you have joined the ranks of professional installers across the country that believe there is no substitute for quality. Viega has a history of bringing high quality and innovative technology to the world.

Our engineers research and develop complete systems that provide you the most effective and easy-to-use products available. Viega Systems are a fast and reliable way to install various piping systems. They provide added benefit without flames while making connections in seconds, keeping projects on time and within budget.

Viega Systems also incorporate the Smart Connect® feature. This patented feature ensures the leakage of liquids and/or gases past the sealing element of unpressed fittings during pressure testing. The Smart Connect feature is removed during the pressing process creating a leak-free permanent mechanical joint connection.

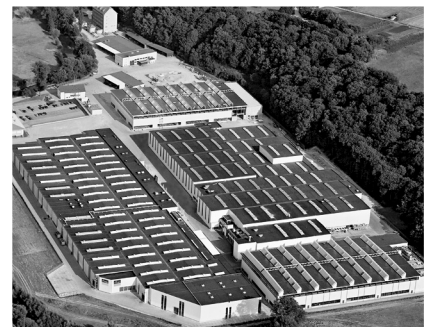

CONTENTS

1 System Description	
1.1 Viega Metal Systems	4
1.2 Special Features	4
2 Seals and Gaskets	
2.1 EPDM Sealing Element	6
2.2 FKM Sealing Element	6
2.3 HNBR Sealing Element	6
2.4 Viega Flange Gasket	6
3 SC Feature	
3.1 Viega SC Feature	7
3.2 Testing	7
4 Press Tools	
4.1 Tools	8
4.2 Pressing Tools	8
5 General Installation Instructions	
5.1 Minimum Distance Between Fittings	9
5.2 Pressing In Tight Quarters	9
5.3 Minimum Space Requirements for the Press Fitting Process in Front of and Behind from Components	9
5.4 Transition Connections	12
5.5 Pipe Supports	12
5.6 Minimum Space Requirements for the 2-1/2" – 4" (64 mm - 108 mm) Press Fittings Upstream and Downstream from Components	12
6 Areas of Applications	
6.1 Commercial and Residential	13
6.2 Industrial and Plant Operations	13
6.3 Shipbuilding	13
6.4 Fire Sprinkler Systems	13
6.5 Fuel Gas Systems	13
6.6 Underground Installation	13
7 ProPress Copper Fittings 1/2" – 4"	
7.1 Tube Selection	14
7.2 Handling Instructions	14
7.3 ProPress to Existing Solder Fitting	14
7.4 Soldering or Brazing Near an Existing ProPress Fitting	14
7.5 Welding Adjacent to ProPress Fittings	14
7.6 Rotating a Pressed Fitting	14
7.7 Codes and Approvals	15
7.8 ProPress 1/2" – 2" Installation	15
7.9 ProPress XL® Installation	16
7.10 ProPress XL-C Installation	17
8 ProPress Stainless Pipe and Fittings 1/2" – 4"	
8.1 Viega Press Systems Pipes	18
8.2 Handling Instructions	18
8.3 Welding Near ProPress Stainless Fittings	18
8.4 Rotating a Pressed Fitting	18
8.5 Codes and Approvals	18
8.6 ProPress Stainless 1/2" – 4" Installation	19
8.7 ProPress Stainless 2-1/2" – 4" Installation	19
9 Profipress (Metric Copper) 12 mm – 108 mm	
9.1 Tube Selection	21
9.2 Handling Instructions	21
9.3 Soldering Near Profipress Fittings	21
9.4 Rotating a Pressed Fitting	21
9.5 Codes and Approvals	21
9.6 Profipress 15 mm – 54 mm Installation	21
9.7 Profipress 64 mm – 108 mm Installation	22
10 Seapress (Metric Cu-Ni-Fe) Fittings 15 mm – 108 mm	
10.1 Tube Selection	24
10.2 Handling Instructions	24
10.3 Welding Near Seapress Fittings	24
10.4 Rotating a Pressed Fitting	24
10.5 Codes and Approvals	24
10.6 Seapress 15 mm – 54 mm Installation	24
10.7 Seapress 64 mm – 108 mm Installation	25
11 Sanpress INOX (Stainless Metric) Pipe and Fittings 15 mm – 108 mm	
11.1 Viega Press Systems Pipe	27
11.2 Handling Instructions	27
11.3 Welding Near Sanpress INOX Fittings	27
11.4 Rotating a Pressed Fitting	27
11.5 Codes and Approvals	27
11.6 Sanpress INOX 15 mm – 54 mm Installation	27
11.7 Sanpress INOX 64 mm – 108 mm Installation	28
12 ProPressG	
12.1 Welcome	30
12.2 Intent	30
12.3 History	30
13 System Description	
13.1 System Description	31
13.2 Applications	31
13.3 Product Description	31
13.4 Advantages	31
13.5 Approvals and Certifications	31
14 ProPressG Applications	
14.1 Fuel Gas Systems	32
14.2 Natural Gas/LP Gas Systems	32
14.3 Mixed Gases	32
14.4 Fuel Oil Systems	32
15 Product Description	
15.1 Fittings	33
15.2 HNBR Sealing Element	33
15.3 Copper Tubing	33
15.4 Pressing Process Overview	34
15.5 Press Connections	35
15.6 The Connection Process	35
15.7 Approvals	36
16 Installation Requirements	
16.1 Clearance Requirements	46
16.2 Protection of Tubing	46
16.3 Appliance Stub Out	47
16.4 Tubing Hangers	47
16.5 Cutting Tubing	48
16.6 Threaded Adapter	48
16.7 Pressure Testing	48
16.8 Tubing Exposed to Freezing Temperatures	48
16.9 Concealed Spaces	48
16.10 Underground Installations	48
16.11 Identification	48
16.12 Installation Instructions	50
17 System Design and Sizing	
17.1 System Design	51
17.2 System Sizing	52

1. SYSTEM DESCRIPTION

1.1 Viega Metal Systems

General

Viega Metal Systems is the state-of-the-art press fitting system that provides an economical and reliable installation of metal tubing for the commercial, industrial and marine markets.

The Systems

Our products are the result of decades of experience in manufacturing fittings. Viega Metal Systems are offered in the following configurations:

ProPress: Copper and Zero Lead Bronze Alloy fittings in inch copper tube size (CTS) with Smart Connect® feature.

ProPressG: Copper and Copper Alloy fittings for use with fuel gas in inch copper tube size (CTS) with the Smart Connect feature.

ProPress Stainless: 304 and 316 Stainless steel pipe and fittings in inch tube size with Smart Connect feature.

Seapress: Copper Nickel (CuNiFe) fittings in metric sizes.

Sanpress INOX: 316 stainless steel pipe and fittings in metric sizes with the Smart Connect feature.

Profipress: Copper and Copper Alloy fittings in metric sizes with the Smart Connect feature.

Smart Connect Feature

Viega Metal System fittings have a Smart Connect feature on all products except Seapress.

By means of the Smart Connect feature on Viega Metal Systems fittings, an unpressed connection can be recognized by escaping water, or by a drop in pressure, when testing the system.

Fitting connections without the Smart Connect feature may not leak initially; however, later they can unseat during system operations. When the fitting is pressed, the Smart Connect feature is reformed and a permanent, sealed, non-detachable, mechanical connection is created.

Other systems without the Smart Connect feature may not leak initially; however, later they can unseat in future system operations. The Smart Connect feature is designed to protect from the potential risk of unpressed fittings.

Press fittings require no soldering or welding, and thus no fire hazard, which is particularly important in restoration or retrofit work. The press fittings are installed with the system pressing tools (a battery powered or corded pressing tool).

Grip Ring

Viega fittings 2-1/2" - 4" and 64 mm – 108 mm fittings feature an EPDM sealing element, stainless steel grip ring, and PBT separator ring as shown in Figure 1.1 (ProPress XL Bronze fittings do not require a PBT separator ring).

The grip ring comes standard in all fitting 2-1/2" – 4" and 64mm – 108mm. The grip ring is a stainless steel ring with teeth, which grips the tube or pipe and ensures that the fitting is locked securely to the tubing.

The PBT (Polybutylene Terephthalate) separator ring ensures that the sealing element and grip ring perform at a maximum capacity by providing a positive physical separation.

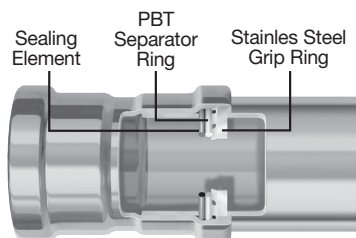

Feature 1.1

Appropriate clamping jaws and actuator rings are available for various dimensions. The constant compression always produces a positive, non-detachable, mechanical joint which ensures a permanent connection.

1.2 Special Features

ProPress Copper and Copper Alloy fittings contain 0% lead in accordance with California AB 1953, Vermont Act 193 and NSF 61 Annex G. Fast and Easy

One squeeze of the trigger makes the connection on any size tube or pipe in four to seven seconds.

Flameless

No flame is required to make the connection. This eliminates noxious fumes, the need for a hot work permit and a fire watch.

Versatility

Viega Metal Systems can be used virtually anywhere – in industrial, marine, commercial and residential applications, for both new installations and retrofit work.

Permanent Watertight Seal

The system provides a strong, reliable, watertight seal. The high strength connection, installed properly, will last for the life of the system.

Wide Capacity

Viega Metal Systems are designed to handle tube and pipe systems, ranging in sizes from 1/2" to 4" in (12 mm – 108 mm) diameter. You can easily switch from one size to another simply by changing the jaws or rings of the press tool.

World's Largest Selection of Fittings

There are more than 3,000 different engineered fittings available in a variety of materials, configurations and sizes.

Professional Appearance

Because there is no buildup of joining material, exposed threads, or tarnish, Viega Metal System connections have a clean, professional look.

Less Equipment

With Viega Metal Systems there is no need to buy or carry expensive cumbersome equipment. Welding tanks and threading machines are a thing of the past.



2. SEALS AND GASKETS

2.1 EPDM Sealing Element

Operating temperature:
0°F to 250°F (-18°C to 120°C)

Viega Metal Systems press fittings are manufactured with a high-quality EPDM sealing element installed at the factory. This sealing element is used mainly in the applications of potable water, hydronic heating, fire sprinkler and compressed air installations. EPDM, or ethylene-propylene diene monomer, is shiny black in color. The EPDM sealing element is a synthetically manufactured and peroxidically cross-linked general purpose elastomer with a wide range of applications.

It possesses excellent resistance to aging, ozone, sunlight, weathering, environmental influences, alkalis and most alkaline solutions and chemicals used in a broad range of applications.

The EPDM sealing element has particularly good resistance to hot water, making it ideal for seals and gaskets in heating systems, fittings and household appliances (e.g. washing machines, pumps, dishwashers).

2.2 FKM Sealing Element

Operating temperature:
0°F to 250°F (-18°C to 120°C)

FKM is well known for its excellent resistance to petroleum products and solvents as well as excellent high temperature performance. The FKM sealing element is a specialty purpose elastomer typically installed where higher temperatures and pressures are required.

FKM, or Fluoroelastomer, is dull black in color. It possesses excellent resistance to aging, ozone, sunlight, weathering, environmental influences, oils and petroleum-based additives. Its excellent resistance to high temperatures and petroleum based additives makes it

ideal for seals and gaskets in solar, district heating, low-pressure steam and compressed air system fittings. In solar applications it is resistant to heat spikes up to 320°F.

2.3 HNBR Sealing Element

This sealing element is used mainly for applications of natural gas, propane, mixed and manufactured fuel gases in the vapor state (not in the liquid state). It is commonly used in fuel oil heating systems. HNBR, or Hydrogenated Nitrile Butadiene Rubber, is yellow in color for easy identification.

Ambient Operating temperature:
-40°F to 180°F (-40°C to 82°C)

HNBR is widely known for its physical strength and retention of properties after long-term exposure to heat, oil and chemicals.

The unique properties attributed to HNBR have resulted in wide adoption of HNBR in automotive, industrial and assorted high performance applications (i.e. Engine seals, grommets, gaskets; Fuel system seals and hoses; Transmission system bonded piston seals; Oil field packers and rotary shaft seals).

With its excellent performance for the most demanding of applications, HNBR is the ideal choice for applications needing excellent physical properties, as well as oil, heat and/or chemical resistance.

All sealing elements are inserted into the fitting, using an H1 Grade lubricant registered with NSF, the USDA and approved for use under FDA 21 CER.

For specific applications, please contact your local Viega District Manager or contact Viega at 1-877-843-4262.

2.4 Viega Flange Gasket

Viega Flange gaskets are an asbestos-free gasket material composed of aramide fibers, inorganic fillers and other asbestos substitutes that are resistant to high temperatures.

These fibers and fillers are firmly bonded to high-grade elastomers under elevated pressure and temperature. The gaskets do not contain any color pigments. The material exhibits high tensile strength, as well as shearing resistance. Other characteristic properties of the material are excellent temperature resistance, stress resistance under high operating pressure and ease of handling.

The gasket material has a nonstick top and bottom layer with a low coefficient of friction. This aids in dismantling. Additional surface treatment is not needed in most cases.

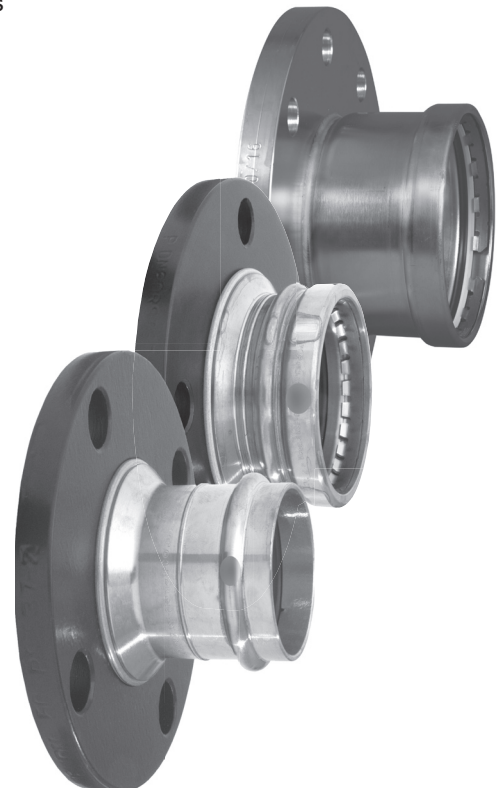

3. SMART CONNECT FEATURE

3.1 Viega Smart Connect Feature

In ProPress 1/2" to 4" (15 mm – 108 mm) dimensions, the Smart Connect® feature (Fig. 3.1) assures leakage of liquids and/or gases from inside the system past the sealing element of an UNPRESSED connection. The function of this feature is to provide the installer quick and easy identification of connections that have not been pressed prior to putting the system into operation (Fig. 3.3).

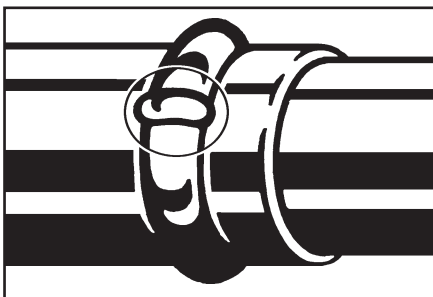

Figure 3.1: The Smart Connect feature of Viega press fittings is color marked on the bead

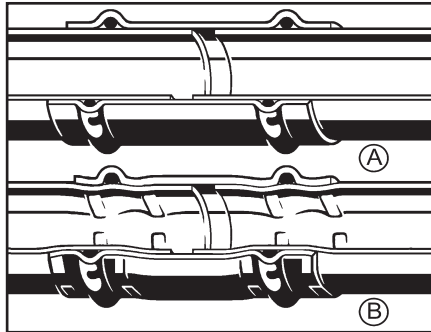

Figure 3.2: Section of a press fitting in unpressed (A) and pressed (B) condition

When the fitting is pressed, the Smart Connect feature is reformed and thus loses its effect (Fig. 3.2). A permanent, sealed, non-detachable, mechanical connection is created.

Press systems without the Smart Connect feature may not leak initially; however, later they can unseat in future system operations. The Smart Connect Feature is designed to protect from this potential risk.

3.2 Testing

All system testing shall be carried out in accordance to the local code or body having jurisdiction. Connections may be tested to a maximum of 600 psi. All pipe or tube system testing shall be pressurized to the maximum pressure and length of time required by the code or standard having jurisdiction.

The Smart Connect feature is a quick and easy way for installers to identify connections that need pressing. Testing for leaks using the Smart Connect feature is not a replacement for testing to the requirements of local codes or standards.

Water Testing the Smart Connect Feature:

When testing the system with water, a pressure range of 15 psi – 85 psi maximum is to be used. This test is in addition to that required by the project specification or local code. If an unpressed fitting is found, check to make sure fitting is fully inserted before completing the press.

Air Testing the Smart Connect Feature:

When testing the system with air, a pressure range of 1/2 psi – 85 psi maximum is to be used. This test is in addition to that required by the project specification or local code. If an unpressed fitting is found, check to make sure fitting is fully inserted before completing the press.



1 Identify an unpressed connection during pressure testing when water flows past the sealing element.

2 Upon identification, the ProPress tool is used to press the fitting, making a permanent leak-proof connection.

3 ProPress connections are fast, flameless, and reliable.

Figure 3.3

4. PRESS TOOLS

4.1 Tools

Viega recommends RIDGID® press tools, ProPress jaws and ring sets manufactured and sold by RIDGID® Tool Company for Viega Systems.

4.2 Pressing Tools

The following RIDGID® pressing tools are available for the Viega pressing systems:

- 210B Battery Powered Press Tool
- RP330 Battery Powered Press Tool
- RP330 Corded ProPress Press Tool



210 - B Battery Pressing Tool Kit
1/2" - 1-1/4" (15mm - 35mm)



RP 330-B
1/2" - 4" (15 mm - 108 mm)



RP 330-C
1/2" - 4" (15 mm - 108 mm)



R2 Actuator for 320 E and CT400 Pressing Tools
2-1/2" - 4" (64 mm - 108 mm)



V2 Actuator for 320 E and CT400 Pressing Tools
2-1/2" - 4" (64 mm - 108 mm)

RIDGID® is a registered trademark of the Ridge Tool Company

5. GENERAL INSTALLATION INSTRUCTIONS

5.1 Minimum Distance Between Fittings

To prevent distortion of the pipe, fittings require a minimum distance between fittings (refer to chart below). Failure to provide this distance may result in an improper seal.

Note: ProPress systems include XL (Bronze) and XL-C (Copper) fittings. All other systems denote XL fittings as the same material as the piping (i.e., Sanpress Inox XL fittings are stainless steel; Seapress XL fittings are copper nickel). XL and XL-C sizes are 2-1/2" – 4" (64 mm – 108 mm).

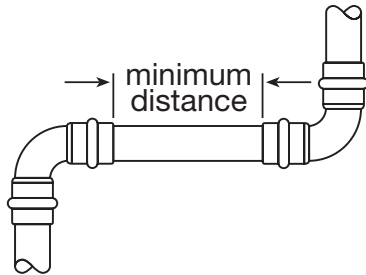

Figure 5.1

Minimum distance between two Viega ProPress® press connections 1/2" to 2"		
Tubing Diameter	Minimum Distance (mm)	Minimum Distance (in)
1/2" (15 mm)	0	0
3/4" (18 mm)	0	0
1" (22 mm)	0	0
1-1/4" (35 mm)	10	7/16
1-1/2" (42 mm)	15	5/8
2" (54 mm)	20	3/4

Minimum distance between two Viega ProPress® XL-C copper press connections 2-1/2" to 4"		
Tubing Diameter	Minimum Distance (mm)	Minimum Distance (in)
2-1/2" (64 mm)	15	5/8
3" (88 mm)	15	5/8
4" (108 mm)	15	5/8

Minimum distance between two Viega ProPress XL® press connections 2-1/2" to 4"		
Tubing Diameter	Minimum Distance (mm)	Minimum Distance (in)
2-1/2" (64 mm)	0	0
3" (88 mm)	0	0
4" (108 mm)	0	0

For installations where the minimum distance is 0, it is particularly important to ensure the correct insertion depth of the tubing into each fitting.

5.2 Pressing in Tight Quarters

The minimum distance between piping, or the piping and the wall/ceiling construction, must be taken into consideration in the planning phase for a problem-free work process. The following figures illustrate the clearance requirements for the jaws and fittings and the procedure for pressing fittings in tight quarters.

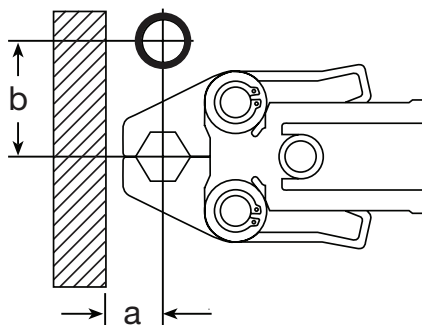

Tube Diameter	a minimum		b minimum	
	inch	mm	inch	mm
1/2" (15 mm)	3/4	19	2	50
3/4" (18 mm)	7/8	22	2-3/8	60
1" (22 mm)	7/8	22	2-3/4	70
1-1/4" (35 mm)	1-1/8	29	3-3/8	85
1-1/2" (42 mm)	1-3/4	45	4	100
2" (54 mm)	2	50	4-1/2	115

Minimum distance requirements for press jaws between pipes and wall/floor structure.

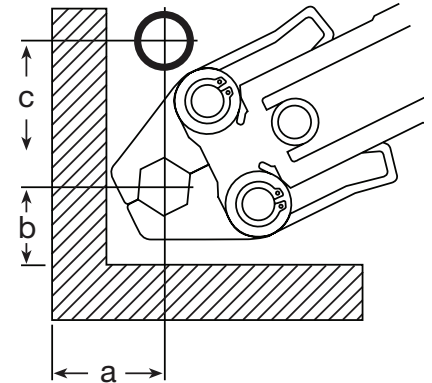

Tube Diameter	a minimum		b minimum		c minimum	
	inch	mm	inch	mm	inch	mm
1/2" (15 mm)	7/8	23	1-3/8	35	2-1/2	64
3/4" (18 mm)	1	26	1-1/2	38	2-1/2	64
1" (22 mm)	1-1/8	29	1-3/4	45	3	76
1-1/4" (35 mm)	1-1/4	32	2-1/4	57	3-1/8	80
1-1/2" (42 mm)	1-7/8	48	2-1/2	64	3-3/4	95
2" (54 mm)	2-1/8"	54	3-1/8	80	5	127

5.3 Minimal Space Requirements for the Press Fitting Process in Front of and Behind from Components

Ensure that the space required for Viega system pressing tools is available if press fittings will be executed immediately upstream and downstream from ceiling penetrations.

V2 Pressing in Tight Quarters

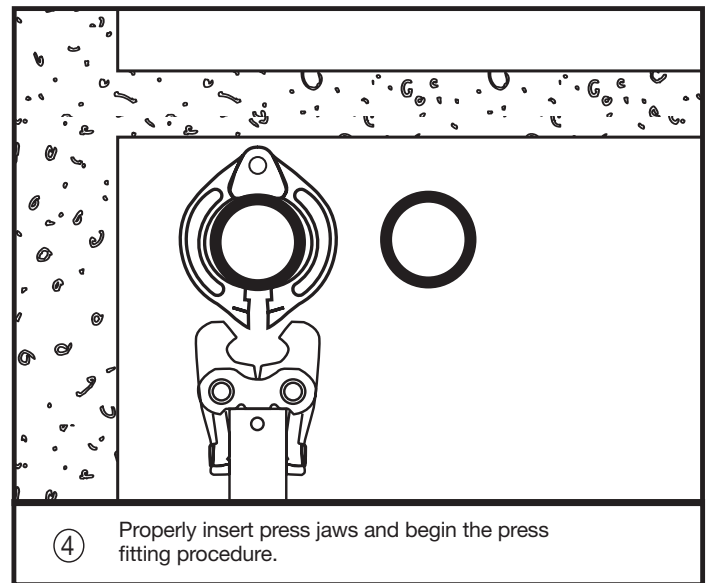
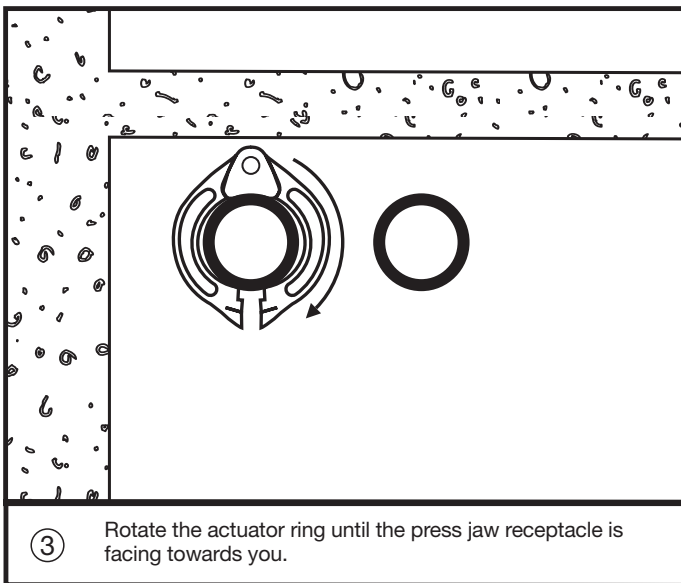
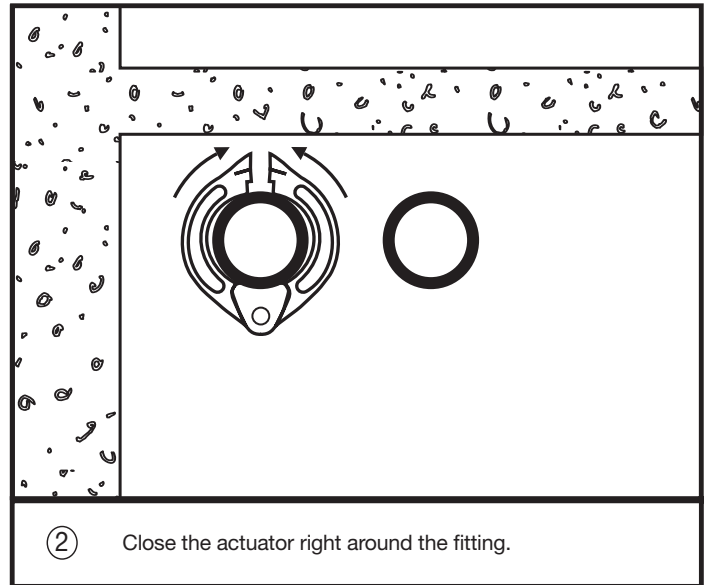
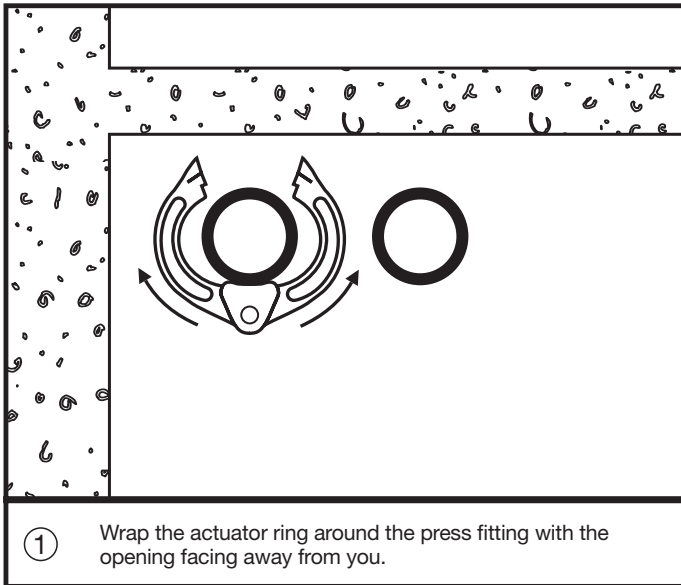

Procedure for the laying the XL-C Press Ring around the XL-C press fitting with minimum space requirements.

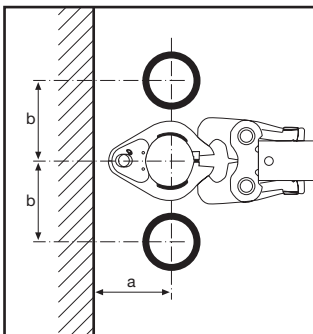

V2 Actuator

Tubing Diameter	a inches (mm)	b inches (mm)
2-1/2"	4-1/8 (105)	6 (152)
3"	4-3/8 (111)	7 (178)
4"	5 (127)	8 (203)

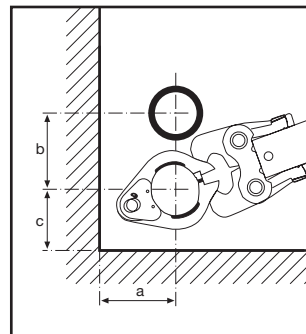

V2 Actuator

Tubing Diameter	a inches (mm)	b inches (mm)	c inches (mm)
2-1/2"	4-1/8 (105)	6 (152)	4-1/2 (114)
3"	4-3/8 (111)	7 (178)	4-7/8 (124)
4"	5 (127)	8 (203)	5-3/4 (146)

R2 Pressing in Tight Quarters

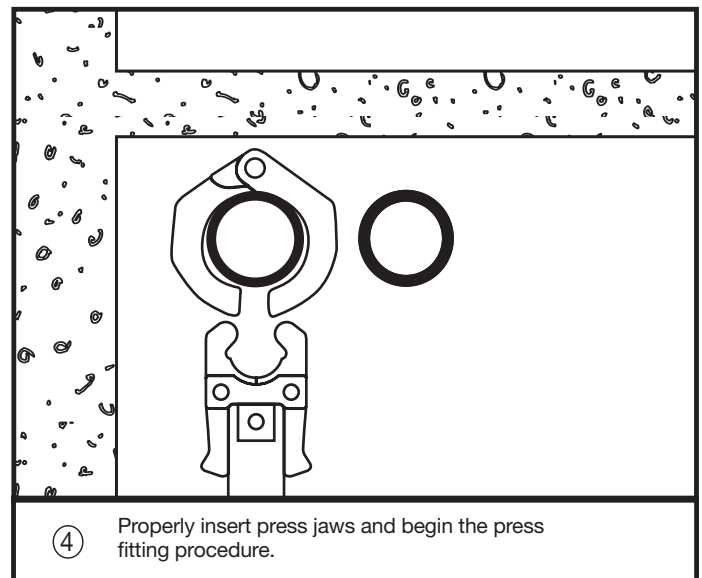
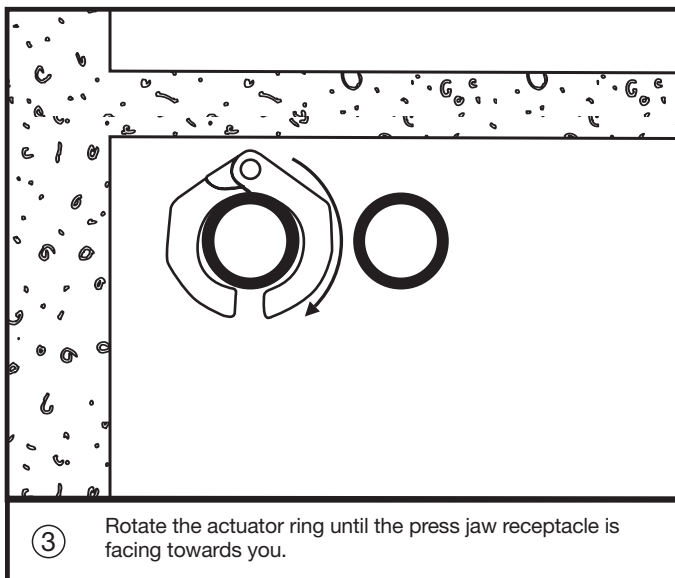
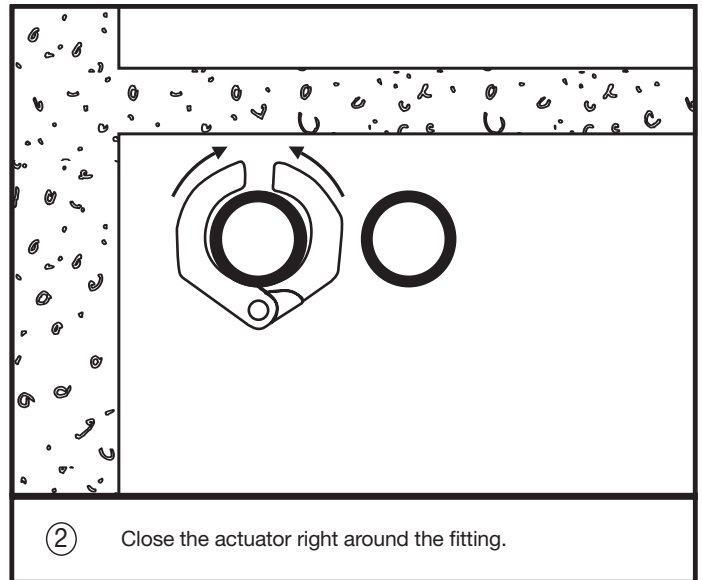
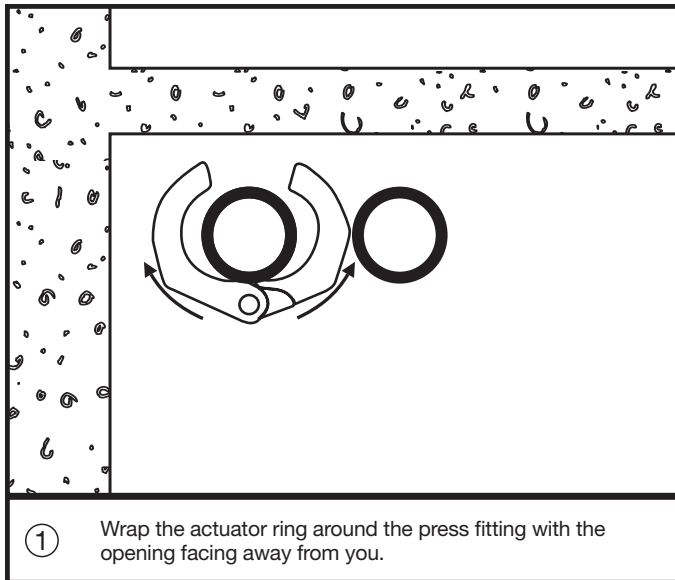

Procedure for the laying the XL Press Ring around the XL press fitting with minimum space requirements.

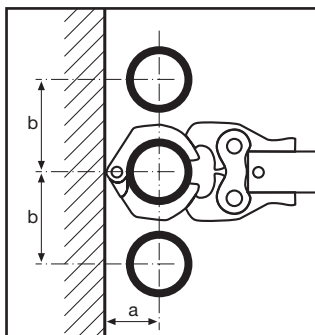

R2 Actuator

Tubing Diameter	a inches (mm)	b inches (mm)
2-1/2"	3-1/2 (90)	5-1/2 (140)
3"	3-7/8 (96)	6-1/2 (165)
4"	4-1/2 (113)	6-7/8 (175)

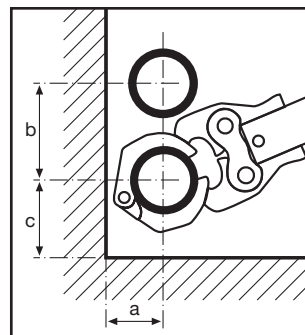

R2 Actuator

Tubing Diameter	a inches (mm)	b inches (mm)	c inches (mm)
2-1/2"	3-1/2 (90)	5-1/2 (140)	3-1/4 (80)
3"	3-7/8 (96)	6-1/2 (165)	3-1/2 (90)
4"	4-1/2 (113)	6-7/8 (175)	4-1/8 (103)

5.4 Transition Connections

Threaded Connections

The Viega Metal Systems 1/2" – 4" (15 mm – 108 mm) can be joined with off-the-shelf threaded fittings (thread in accordance with DIN 2999) or armatures made of non-ferrous metals.

In this regard:

- ① The threaded connection is made first.
- ② The press fitting is made.

This process avoids unnecessary torsion.

Flange Connections

When using Viega flanges, bolt the flange end in place prior to pressing the fitting to the tubing.

5.5 Pipe Supports

Pipe supports perform two functions. The first function is to provide support for the piping system.

The second function is to guide the pipe or tube during thermal expansion and contraction. Industry standard practices and guidelines shall be used for piping layout and support. Viega press connections require no special consideration for support.

5.6 Minimum Space Requirements for the 2-1/2" - 4" (64 mm - 108 mm) Press Fittings Upstream and Downstream from Components

If 2-1/2" – 4" (64 mm – 108 mm) press fittings will be installed immediately upstream and downstream from ceiling penetrations, then ensure that the space required for Viega system pressing tools is available. Minimum distance requirements for the respective Viega system pressing tools are listed in 5.2 and 5.3.

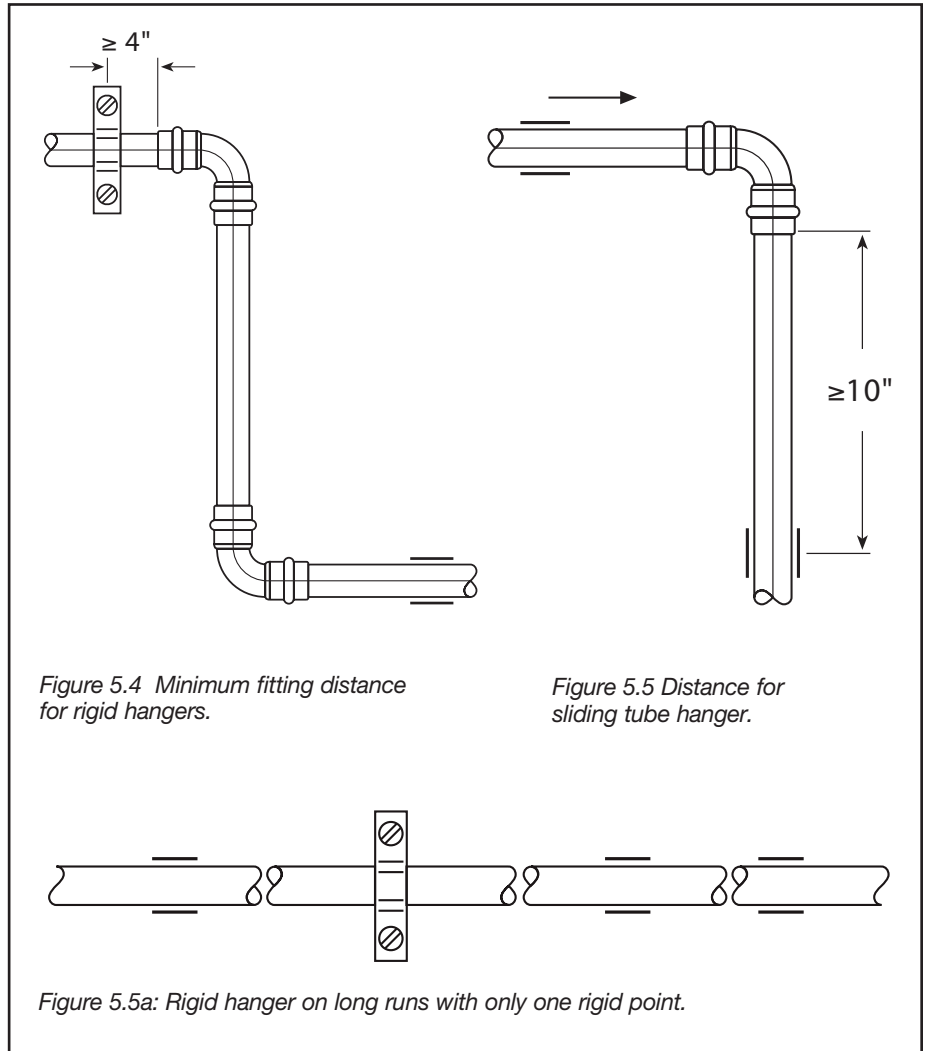
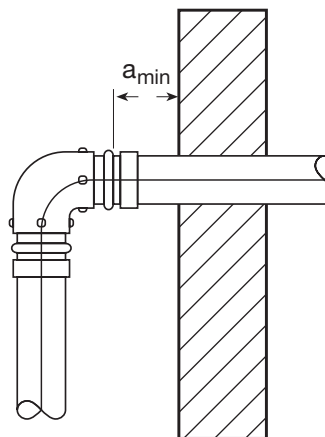

Figure 5.4 Minimum fitting distance for rigid hangers.

Figure 5.5 Distance for sliding tube hanger.

Figure 5.5a: Rigid hanger on long runs with only one rigid point.



Pipe Size	Minimum distance requirement a	
	330-B	330-C
2-1/2" – 4" (64 mm – 108 mm)	2" (50 mm)	2" (50 mm)

Table 5.2: Distance requirements for pressing tools for XL press fittings upstream and downstream from wall/ceiling penetrations

6. AREAS OF APPLICATION

6.1 Commercial and Residential

The ProPress System is approved for applications in the commercial and residential market. The ProPress system is approved for potable water applications. "Zero Lead" identifies Viega products meeting the lead free requirements of California and Vermont law, effective January 1, 2010, as tested and listed against NSF- 61, Annex G. For additional applications please refer to the approved application chart or consult your local Viega District Manager.

6.2 Industrial and Plant Operations

The Viega Metal Systems are also suitable for use in the area of industrial and plant processes. Primary areas of application are utility piping systems. The Viega Metal Systems in 2-1/2" – 4" (64 mm – 108 mm) are also employed in industrial applications in which connectors consisting of substances which will not interfere with paint and lacquer application processes are required. Your local Viega District Manager should be consulted regarding the use of Viega Metal Systems in areas not covered by Viega literature.

6.3 Shipbuilding

Viega Metal Systems are approved for shipbuilding by the following certifying bodies:

- Lloyd's Register
- Germanischer Lloyd
- Det Norske Veritas
- Registro Italiano
- Navale
- Bureau Veritas
- American Bureau of Shipping
- United States Coast Guard

6.4 Fire Sprinkler Systems

Viega Press fittings (XL only) can be installed in NFPA 13, 13R and 13D fire sprinkler systems. They are certified for use in "wet" and "dry" fire sprinkler piping in accordance with UL certifications.

- VIZM.EX6157 (Sprinkler Pipe Fittings) Fittings, Rubber-Gasketed
- VIZM7.EX6157 (Piping, Sprinkler Systems Certified for Canada) Fittings, Rubber Gasketed Certified for Canada



6.5 Fuel Gas Systems

Viega Metal System fittings with HNBR sealing element are suitable for applications that include:

- Natural Gas
- Liquid Propane Gas
- Mixed Fuel Gases (vapor state only)
- Manufactured Fuel Gases
- Butane
- Fuel Oil Heating Systems
- Carbon Dioxide CO₂ (dry)
- Vacuum 29.2" Mercury
- Diesel Fuel
- Motor Oil

6.6 Underground Installation

Viega fittings can be used in underground applications unless otherwise specified. However, any installation must meet all state and local codes, including those for underground applications. Proper authorization must be obtained prior to installation from the local authority having jurisdiction. If you have any questions or if we can be of any further assistance, please contact your local Viega District Manager.



ProPress XL-C



Sanpress



Seapress

7. PROPRESS COPPER FITTINGS 1/2" - 4"

7.1 Tube Selection

Viega ProPress copper and bronze fittings are compatible with 1/2" – 1-1/4" soft copper tube and 1/2" – 4" hard copper tubing type K, L, and M copper tubing. All copper tubing that is to be used with the ProPress copper and bronze fittings must comply with ASTM B88 standards.

7.2 Handling Instructions

ProPress components shall be free from dirt, debris, or items that may interfere with the sealing element and the press connection.

ProPress sealing elements, separator rings and grip rings are to be visually inspected prior to installation to ensure the seal is intact and properly located within the fitting.

7.3 ProPress to Existing Solder Fitting or Brazed Fitting

Minimum clearance requirement when pressing connections near an existing brazed connection is 2 pipe diameters.

To ensure proper sealing of both the soldered and press connections, a minimum spacing between connections must be maintained.

Note: It is particularly important to ensure there is no residual solder or other foreign debris on the tubing to be inserted into the press fitting.

Tube Dia.	Minimum distance inch (mm)
1/2"	1/4 (6)
3/4"	1/4 (6)
1"	7/16 (10)
1-1/4"	7/16 (10)
1-1/2"	5/8 (15)
2"	3/4 (20)
2-1/2"	1/4 (6)
3"	1/4 (6)
4"	1/4 (6)

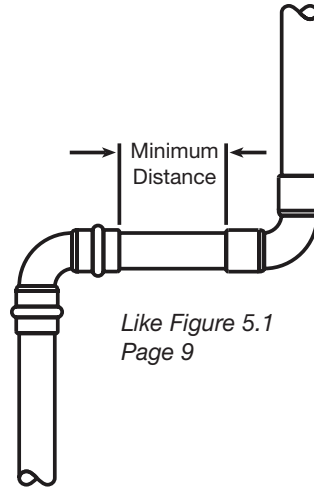

7.4 Soldering or Brazing Near an Existing ProPress Fitting

When soldering or brazing near a ProPress connection, the installer must remain at least three tube diameters away from the connection to prevent damage to the sealing element.

To ensure proper sealing of the soldered/brazed joint and the press connection a minimum distance between connections must be maintained.

The installer should take precautions to keep the ProPress connection cool. These include:

- Wrapping the connection with a cold wet rag
- Fabricating solder connections prior to installing the pressed fitting making sure the tube has cooled before installing the fitting
- Applying "spray type" spot freezing

It is particularly important to ensure the tubing inserted into the ProPress fitting as well as the ProPress fitting are not exposed to excessive heat.

7.5 Welding Adjacent to ProPress Fittings

When welding adjacent to a ProPress connection, the installer must remain 4" away from the connection to prevent damage to the sealing element. The installer should take precautions to keep the ProPress connection cool while welding, these include:

- Wrapping the connection with a cold wet rag
- Protecting the connection with a weld blanket
- Fabricating weld connections prior to installing the pressed fitting making sure the tube has cooled before installing the fitting
- Consistently applying "spray type" spot freezing

7.6 Rotating a Pressed Fitting

Once a ProPress fitting has been pressed it can be rotated (not by hand), but once rotated more than 5 degrees, the fitting must be re-pressed to restore the resistance to rotational movement.

Tube Dia.	Minimum distance inch (mm)
1/2"	1-1/2 (38)
3/4"	2-1/4 (57)
1"	3 (76)
1-1/4"	3-3/4 (95)
1-1/2"	4-1/2 (114)
2"	6 (152)
2-1/2"	7-1/2 (191)
3"	9 (229)
4"	12 (305)

7.7 Codes and Approvals

NSF International Annex G

IAPMO

UL

ABS (American Bureau of Shipping)

CSA International

FM

Compliant with:

- ICC International Plumbing Code
- UPC Uniform Plumbing Code
- PHCC National standard plumbing code
- Florida Building Code, Volume II Plumbing Code
- NFPA 13,13D and 13R

7.8 Zero Lead* ProPress 1/2" – 2" Installation



Read and understand all instructions for installing ProPress fittings. Failure to follow all instructions may result in extensive property damage, serious injury, or death.

1. Cut copper tubing at right angles (using displacement type cutter or fine-toothed steel saw).

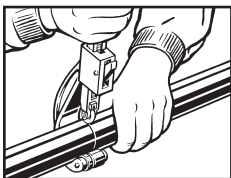

2. Deburr tubing on inside and outside to prevent cutting fitting seal.

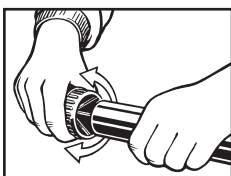

3. Check seal for correct fit. Do not use oils or lubricants. Use only ProPress shiny black EPDM or dull black FKM sealing elements.

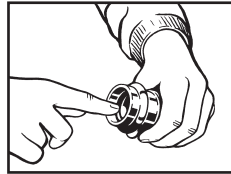

4. While turning slightly, slide press fitting onto tubing to the fitting stop. End of tubing must contact stop.

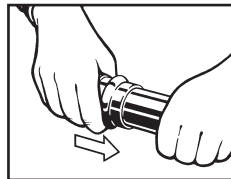

5. Mark insertion depth.

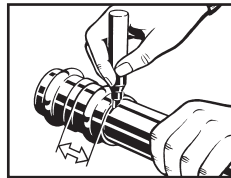

ProPress Insertion Depth Chart						
Tube Size	1/2"	3/4"	1"	1-1/4"	1-1/2"	2"
Insertion Depth	3/4"	7/8"	7/8"	1"	1-7/16"	1-9/16"

6. Insert the appropriate jaw into the pressing tool and push in holding pin until it locks into place.

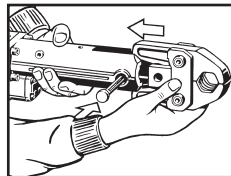

7. Open the jaw and place at right angles on the fitting. Visually check insertion depth using mark on tubing.

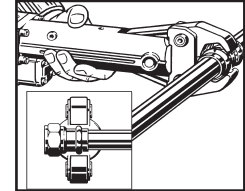

8. Start pressing process and hold the trigger until the jaw has engaged the fitting.

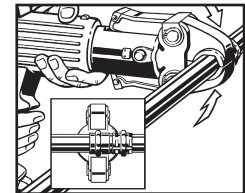

9. After pressing, the jaw can be opened again.

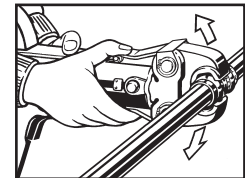

10. For applications requiring ProPress with FKM sealing elements, remove the factory installed EPDM sealing element and replace with FKM sealing element.

* "Zero Lead" identifies Viega products meeting the lead free requirements of California and Vermont law, effective January 1, 2010, as tested and listed against NSF- 61, Annex G

7.9 ProPress XL® Installation



Read, understand and follow all instructions for installing ProPress XL fittings. Failure to follow all instructions may result in extensive property damage, serious injury or death.

1. Cut copper tubing at right angles using displacement type cutter or fine-toothed steel saw.

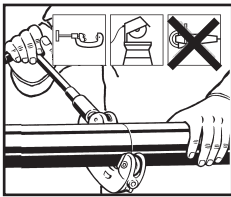

2. Keep end of tubing a minimum of 4" away from the contact area of the vise to prevent possible damage to the tubing in the press area.

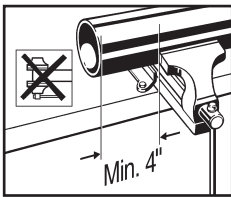

3. Remove burr from inside and outside of tubing to prevent cutting sealing element.

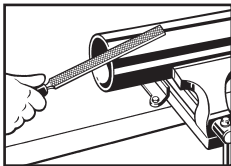

4. Mark proper insertion depth as indicated by the ProPress XL insertion depth chart. Improper insertion depth may result in an improper seal.

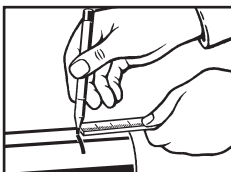

ProPress XL Insertion Depth Chart			
Tube Size	2-1/2"	3"	4"
Insertion Depth	2-1/8"	2-1/8"	2-1/2"

5. Check seal and grip ring for correct fit.

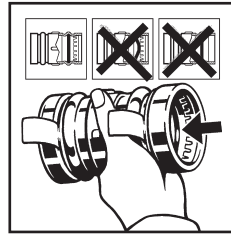

6. While turning slightly, slide press fitting onto tubing to the marked depth. Do not use oils or lubricants.

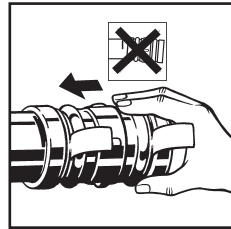

7. ProPress XL fitting connections must be performed with ProPress XL Rings and R2 Actuator. Use of other ring set or actuator will result in an improper connection. See RIDGID® Operator's Manual for proper tool instructions.

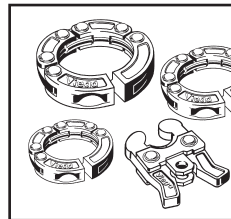

8. Open XL Ring and place at right angle on the fitting. XL Ring must be engaged on the fitting bead. Check insertion depth.

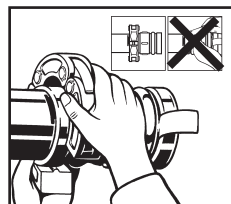

9. With Actuator inserted into the tool, open the Actuator as shown.

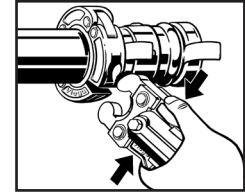

10. Place Actuator onto XL Ring and start pressing process. Hold the trigger until the Actuator has engaged the XL Ring. Keep extremities and foreign objects away from XL Ring and Actuator during pressing operation to prevent injury or incomplete press.

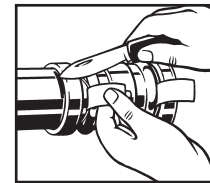

11. Release Actuator from XL Ring and then remove the XL Ring from the fitting on completion of press. Remove tag from fitting, indicating press has been performed.

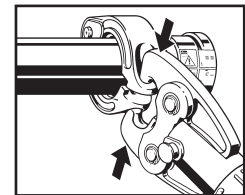

12. For applications requiring ProPress XL with FKM sealing elements, remove the factory installed EPDM sealing element and replace with FKM sealing element.

7.10 Zero Lead* ProPress XL-C



Read, understand and follow all instructions for installing ProPress XL-C fittings. Failure to follow all instructions may result in extensive property damage, serious injury, or death.

1. Cut copper tubing at right angles using displacement type cutter or fine-toothed steel saw.

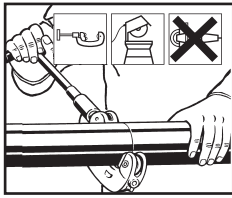

2. Keep end of tubing a minimum of 4" away from the contact area of the vise to prevent possible damage to the tubing in the press area.

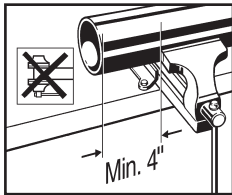

3. Remove burr from inside and outside of tubing to prevent cutting sealing element.

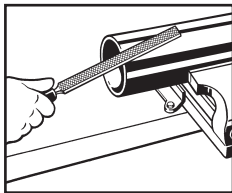

4. Mark proper insertion depth as indicated by the ProPress XL-C insertion depth chart. Improper insertion depth may result in an improper seal.

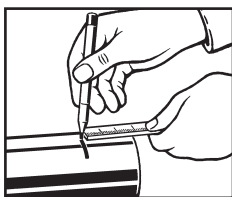

ProPress XL-C Insertion Depth Chart			
Tube Size	2-1/2"	3"	4"
Insertion Depth	1-5/8"	1-7/8"	2-3/8"

5. Check seal and grip ring for correct fit. Illustration demonstrates proper fit of grip ring, separation ring and sealing element. Use only ProPress shiny black EPDM sealing elements.

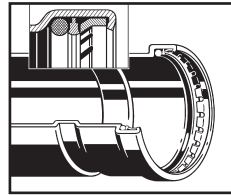

7. While turning slightly, slide press fitting onto tubing to the marked depth. Do not use oils or lubricants.

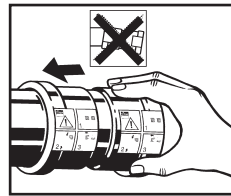

8. ProPress XL-C fitting connections must be performed with ProPress XL-C Rings and V2 ACTUATOR. Use of ProPress XL Rings and/or Actuator (for Bronze fittings) will result in an improper connection. See RIDGID® Operator's Manual for proper tool instructions.

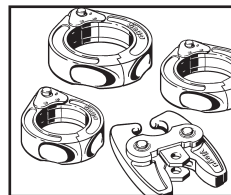

9. Open XL-C Ring and place at right angles on the fitting. XL-C Ring must be engaged on the fitting bead. Check insertion depth.

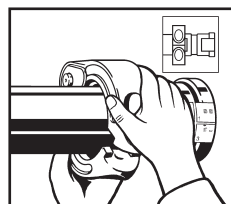

10. With V2 ACTUATOR inserted into the tool, open the V2 ACTUATOR as shown and connect V2 ACTUATOR to the XL-C Ring.

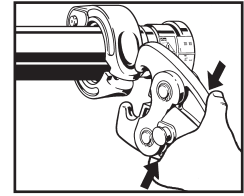

11. Place V2 ACTUATOR onto XL-C Ring and start pressing process. Hold the trigger until the Actuator has engaged the XL-C Ring. Keep extremities and foreign objects away from XL-C Ring and V2 ACTUATOR during pressing operation to prevent injury or incomplete press.

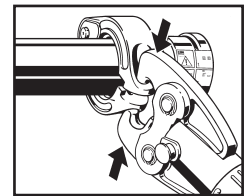

12. Release V2 ACTUATOR from XL-C Ring and then remove the XL-C Ring from the fitting on completion of press. Remove tag from fitting, indicating press has been performed.

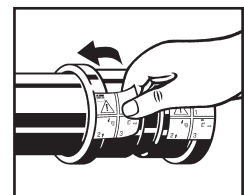

* "Zero Lead" identifies Viega products meeting the lead free requirements of California and Vermont law, effective January 1, 2010, as tested and listed against NSF- 61, Annex G

8. PROPRESS STAINLESS PIPE AND FITTINGS 1/2" - 4"

8.1 Viega ProPress Systems Pipes

Only Viega ProPress Stainless piping is approved for installation with ProPress Stainless. This is to ensure reliability and conformity with the stainless steel system. ProPress Stainless pipe comes in sizes 1/2" - 4".

General

Viega ProPress Stainless pipes are thicker than schedule 5, inert gas welded pipes, meeting ASTM A312 and DIN 1988.

Delivery Condition

All dimensions of pipe are delivered in sticks that are nominal 20 ft. in length, with a metallic bare exterior and interior surface. The pipes are free from annealing color, corrosion promoting substances and hygienically questionable substances.

All pipes have been tested for leaks. The pipes are subject to continuous monitoring, as well as external monitoring by the material testing office. Viega ProPress Stainless pipes offer these advantages:

- Form-stable
- Prevent fire as no soldering or welding device is required for installation
- Press fitted in seconds
- Low in linear expansion due to heating.

Identification

Viega ProPress Stainless pipes are marked and labeled with the following information along their entire length:

1. System vendor/system name
2. Test marks and approval marks
3. Material number in accordance with DIN specifications
4. Pipe diameter x wall thickness
5. Manufacturing type g = inert gas welded
6. Pipe manufacturer abbreviation
7. Manufacturing date
8. Lot or reel number

8.2 Handling Instructions

ProPress Stainless components shall be free from dirt, debris, scaling, or items that may interfere with the sealing element and the press connection. ProPress Stainless sealing elements are to be visually inspected prior to installation to ensure the seal is intact and properly located within the fitting.

8.3 Welding Near ProPress Stainless Fittings

When welding near a ProPress Stainless connection, the installer must remain at least three feet away from the connection to prevent damage to the sealing element. If three feet is not possible, the installer should take precautions to keep the ProPress Stainless connection cool while welding.

These include:

- Wrapping the connection with a cold wet rag
- Fabricating welded connections prior to installing the pressed fitting making sure the pipe has cooled before installing the fitting
- Consistently applying "spray type" spot freezing

8.4 Rotating a Pressed Fitting

Once a ProPress Stainless fitting has been pressed it can be rotated (not by hand), but once rotated more than five degrees, the fitting must be repressed to restore the resistance to rotational movement.

8.5 Codes and Approvals

NSF-61 Annex G
American Bureau of Shipping
United States Coast Guard
Lloyd's Register
Det Norske Veritas

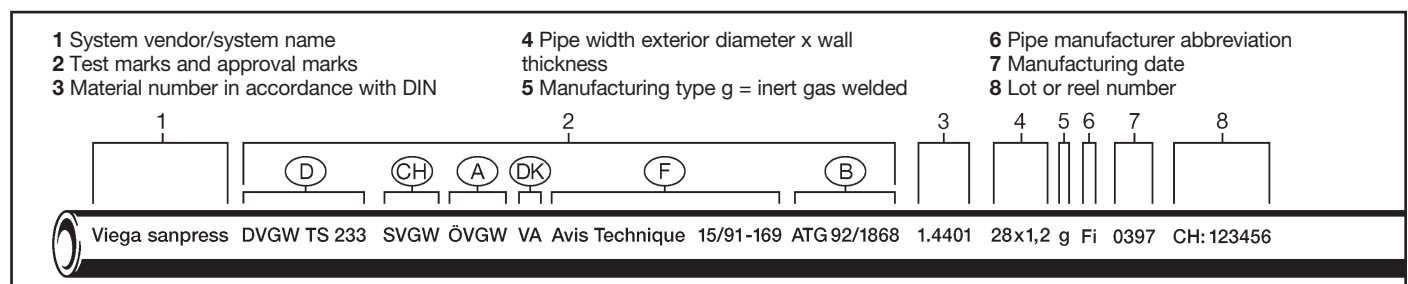

Identification of ProPress Stainless

8.6 ProPress Stainless 1/2" - 4" Installation



Read, understand and follow all instructions for installing ProPress fittings. Failure to follow all instructions may result in extensive property damage, serious injury, or death.

1. Cut stainless steel piping at right angles using displacement type cutter or fine-toothed steel saw.

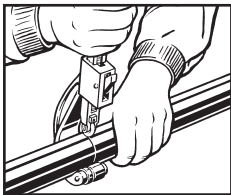

2. Deburr piping on inside and outside to prevent cutting fitting seal.

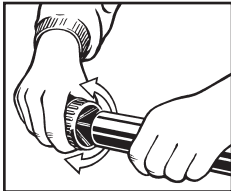

3. Check seal for correct fit. Do not use oils or lubricants. Use only ProPress shiny black EPDM or dull black FKM sealing elements.

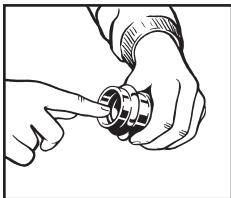

4. While turning slightly, slide press fitting onto piping to the fitting stop. End of tubing must contact stop.

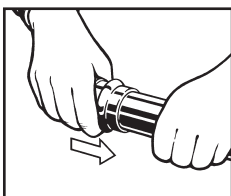

5. Mark insertion depth.

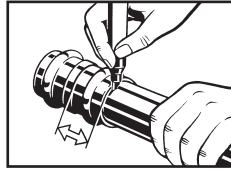

ProPress Stainless Insertion Depth Chart						
Tube Size	1/2"	3/4"	1"	1-1/4"	1-1/2"	2"
Insertion Depth	3/4"	7/8"	7/8"	1"	1-7/16"	1-9/16"

6. Insert the appropriate jaw into the pressing tool and push in holding pin until it locks into place.

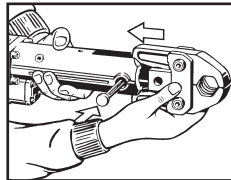

7. Open the jaw and place at right angles on the fitting. Visually check insertion depth using mark on piping.

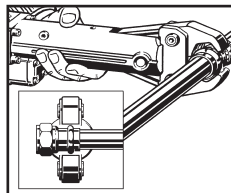

8. Start pressing process and hold the trigger until the jaw has engaged the fitting.

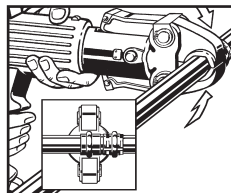

9. After pressing, the jaw can be opened again.

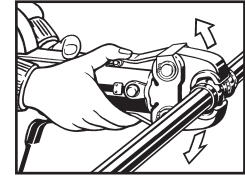

10. For applications requiring ProPress Stainless with FKM sealing elements, remove the factory installed EPDM sealing element and replace with FKM sealing element.

8.7 ProPress Stainless 2-1/2" - 4" Installation



Read, understand and follow all instructions for installing ProPress Stainless fittings. Failure to follow all instructions may result in extensive property damage, serious injury, or death.

1. Cut stainless steel piping at right angles using displacement type cutter or fine-toothed steel saw.

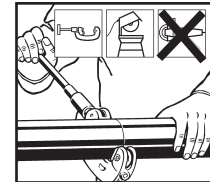

2. Keep end of piping a minimum of 4" away from the contact area of the vise to prevent possible damage to the piping in the press area.

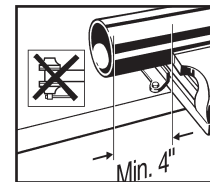

3. Remove burr from inside and outside of piping to prevent cutting sealing element.

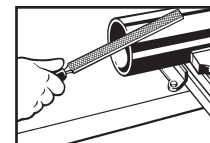

4. Mark proper insertion depth as indicated by the ProPress Stainless insertion depth chart. Improper insertion depth may result in an improper seal.

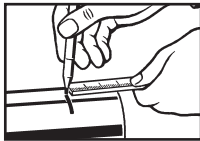

ProPress Stainless Insertion Depth Chart			
Tube Size	2-1/2"	3"	4"
Insertion Depth	1-5/8"	1-7/8"	2-3/8"

5. Check seal and grip ring for correct fit. Illustration demonstrates proper fit of grip ring, separation ring and sealing element. Use only ProPress shiny black EPDM sealing elements.

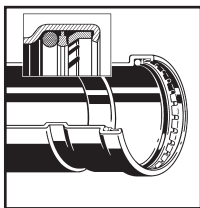

6. While turning slightly, slide press fitting onto piping to the marked depth. Do not use oils or lubricants.

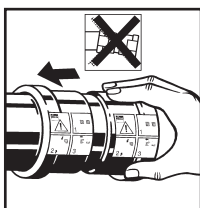

7. ProPress Stainless fitting connections must be performed with ProPress XL-C Rings and V2 ACTUATOR. Use of ProPress XL Rings and/ or Actuator (for Bronze fittings) will result in an improper connection. See RIDGID® Operator's Manual for proper tool instructions.

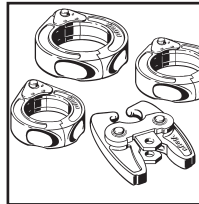

8. Open XL-C Ring and place at right angles on the fitting. XL-C Ring must be engaged on the fitting bead. Check insertion depth.

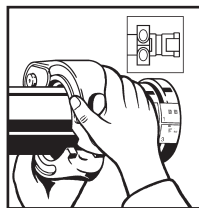

9. With V2 ACTUATOR inserted into the tool, open the V2 ACTUATOR as shown and connect V2 ACTUATOR to the XL-C Ring.

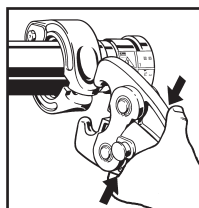

10. Place V2 ACTUATOR onto XL-C Ring and start pressing process. Hold the trigger until the Actuator has engaged the XL-C Ring. Keep extremities and foreign objects away from XL-C Ring and V2 ACTUATOR during pressing operation to prevent injury or incomplete press.

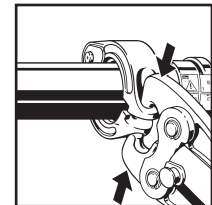

11. Release V2 ACTUATOR from XL-C Ring and then remove the XL-C Ring from the fitting on completion of press. Remove tag from fitting, indicating press has been performed.

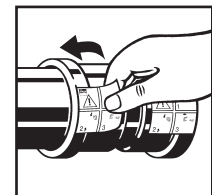

9. PROFIPRESS (METRIC COPPER) 12 MM – 108 MM

9.1 Tube Selection

Viega Profipress copper and bronze fittings are compatible with metric 15 mm through 22 mm soft copper tube and 15 mm through 108 mm hard copper tubing type K, L and M copper tubing.

All copper tubing that is to be used with the Profipress copper and bronze fittings must comply with ASTM B88 standards.

9.2 Handling Instructions

Profipress components shall be free from dirt, debris, or items that may interfere with the sealing element and the press connection.

Profipress sealing elements are to be visually inspected prior to installation to ensure the seal is intact and properly located within the fitting.

9.3 Soldering Near Profipress Fittings

When soldering near a Profipress connection, the installer must remain at least three tube diameters away from the connection to prevent damage to the sealing element.

If three tube diameters is not possible, the installer should take precautions to keep the Profipress connection cool while soldering. These include:

- Wrapping the connection with a cold wet rag
- Fabricating solder connections prior to installing the pressed fitting making sure the tube has cooled before installing the fitting
- Applying "spray type" spot freezing

9.4 Rotating a Pressed Fitting

Once a Profipress fitting has been pressed it can be rotated (not by hand), but once rotated more than five degrees, the fitting must be re-pressed to restore the resistance to rotational movement.

9.5 Codes and Approvals

American Bureau of Shipping
 United States Coast Guard
 Lloyd's Register
 Det Norske Veritas
 Nippon Kaiji Kyokai

9.6 Profipress 15 mm – 54 mm Installation



Read, understand and follow all instructions for installing Profipress fittings. Failure to follow all instructions may result in extensive property damage, serious injury, or death.

1. Cut copper tubing at right angles using displacement type cutter or fine-toothed steel saw.

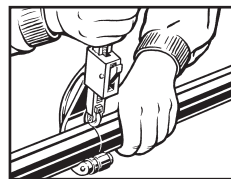

2. Deburr tubing on inside and outside to prevent cutting fitting seal.

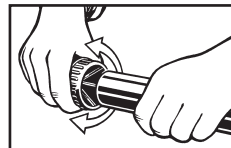

3. Check seal for correct fit. Do not use oils or lubricants. Use only ProPress shiny black EPDM or dull black FKM sealing elements.

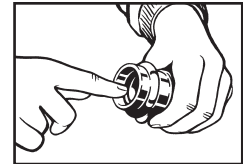

4. While turning slightly, slide press fitting onto tubing to the fitting stop. End of tubing must contact stop.

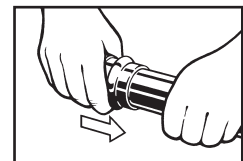

5. Mark insertion depth.

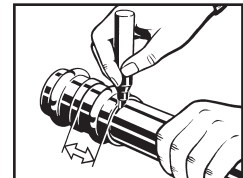

Tube Size (mm)	12	15	18	22	28	35	42	54
Insertion Depth (mm)	18	18	22	22	22	22	36	40

6. Insert the appropriate jaw into the pressing tool and push in holding pin until it locks into place.

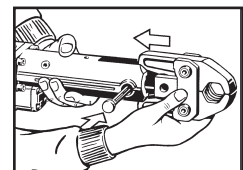

7. Open the jaw and place at right angles on the fitting. Visually check insertion depth using mark on tubing.

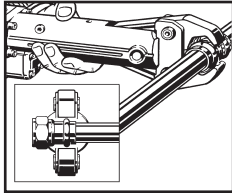

8. Start pressing process and hold the trigger until the jaw has engaged the fitting.

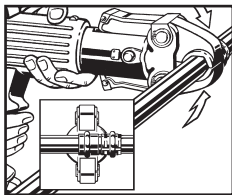

9. After pressing, the jaw can be opened again.

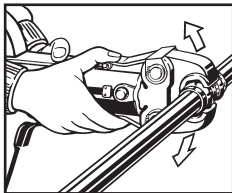

10. For applications requiring ProPress with FKM sealing elements, remove the factory installed EPDM sealing element and replace with FKM sealing element.

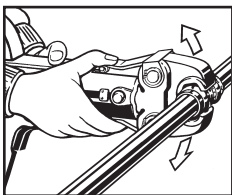

9.7 Profipress 64 mm – 108 mm Installation

 Read, understand and follow all instructions for installing Profipress XL fittings. Failure to follow all instructions may result in extensive property damage, serious injury, or death.

1. Cut copper tubing at right angles using displacement type cutter or fine-toothed steel saw.

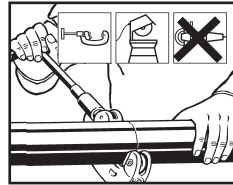

2. Keep end of tubing a minimum of 4" away from the contact area of the vise to prevent possible damage to the tubing in the press area.

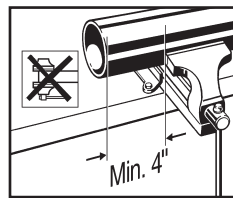

3. Remove burr from inside and outside of tubing to prevent cutting sealing element.

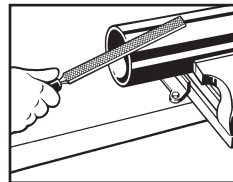

4. Mark proper insertion depth as indicated by the Profipress XL insertion depth chart. Improper insertion depth may result in an improper seal.

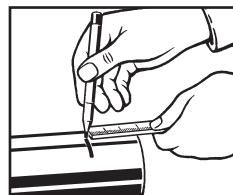

5. Check seal and grip ring for correct fit. Illustration demonstrates proper fit of grip ring, separation ring and sealing element. Use only ProPress shiny black EPDM sealing elements.

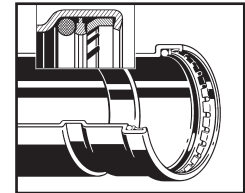

6. While turning slightly, slide press fitting onto tubing to the marked depth. Do not use oils or lubricants.

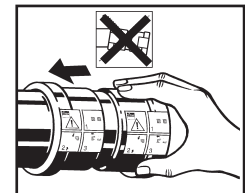

7. Profipress XL fitting connections must be performed with ProPress XL-C Rings and V2 ACTUATOR. Use of ProPress XL Rings and/or Actuator (for Bronze fittings) will result in an improper connection. See RIDGID® Operator's Manual for proper tool instructions.

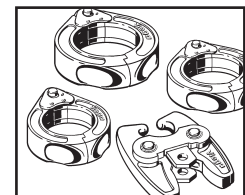

8. Open XL-C Ring and place at right angles on the fitting. XL-C Ring must be engaged on the fitting bead. Check insertion depth.

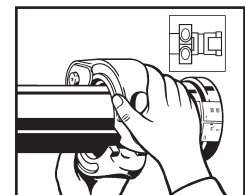

Profipress XL Insertion Depth Chart				
Tube Size (mm)	64	76	88	108
Insertion Depth (mm)	43	50	50	65

9. With V2 ACTUATOR inserted into the tool, open the V2 ACTUATOR as shown and connect V2 ACTUATOR to the XL-C Ring.

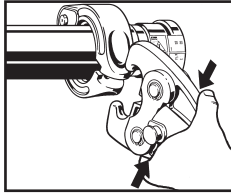

10. Place V2 ACTUATOR onto XL-C Ring and start pressing process. Hold the trigger until the Actuator has engaged the XL-C Ring. Keep extremities and foreign objects away from XL-C Ring and V2 ACTUATOR during pressing operation to prevent injury or incomplete press.

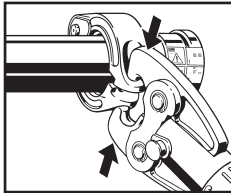

11. Release V2 ACTUATOR from XL-C Ring and then remove the XL-C Ring from the fitting on completion of press. Remove tag from fitting, indicating press has been performed.

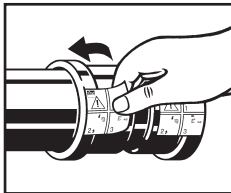

10. SEAPRESS (METRIC Cu-Ni-Fe) FITTINGS 15 MM – 108 MM

10.1 Tube Selection

Viega Seapress fittings are compatible 15mm through 108mm metric seamless drawn tubes consisting of a corrosion resistant copper-nickel wrought alloy material.

All copper-nickel tubing that is to be used with the Seapress copper-nickel fittings must comply with the requirements of DIN 86019.

10.2 Handling Instructions

Seapress components shall be free from dirt, debris, scaling, or items that may interfere with the sealing element and the press connection.

Seapress sealing elements are to be visually inspected prior to installation to ensure the seal is intact and properly located within the fitting.

10.3 Welding Near Seapress Fittings

When welding near a Seapress connection, the installer must remain at least three feet away from the connection to prevent damage to the sealing element.

If three feet is not possible, the installer should take precautions to keep the Seapress connection cool while welding. These include:

- Wrapping the connection with a cold wet rag
- Fabricating welded connections prior to installing the pressed fitting making sure the tube has cooled before installing the fitting
- Consistently applying "spray type" spot freezing

10.4 Rotated a Pressed Fitting

Once a Seapress fitting has been pressed it can be rotated (not by hand), but once rotated more than five degrees, the fitting must be re-pressed to restore the resistance to rotational movement.

10.5 Codes and Approvals

Lloyd's Register
 Germanischer Lloyd
 Det Norske Veritas
 Registro Italiano Navale
 Bureau Veritas
 American Bureau of Shipping
 United States Coast Guard
 Nippon Kaiji Kyokai

10.6 Seapress 15 mm – 54 mm Installation



Read, understand and follow all instructions for installing Seapress fittings. Failure to follow all instructions may result in extensive property damage, serious injury, or death.

1. Cut tubing at right angles using displacement type cutter or fine-toothed steel saw.

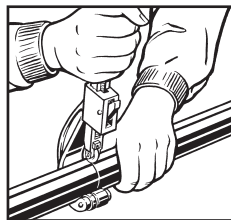

2. Deburr tubing on inside and outside to prevent cutting fitting seal.

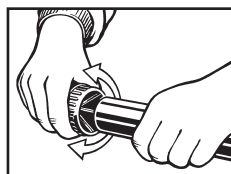

3. Check seal for correct fit. Do not use oils or lubricants. Use only ProPress shiny black EPDM or dull black FKM sealing elements.

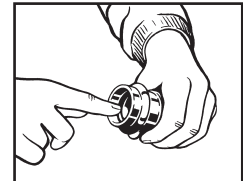

4. While turning slightly, slide press fitting onto tubing to the fitting stop. End of tubing must contact stop.

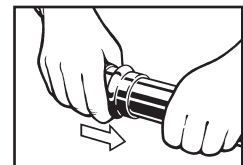

5. Mark insertion depth.

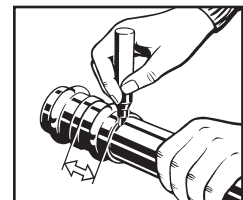

Tube Size (mm)	15	18	28	35	42	54
Insertion Depth (mm)	18	22	22	25	36	40

6. Insert the appropriate jaw into the pressing tool and push in holding pin until it locks into place.

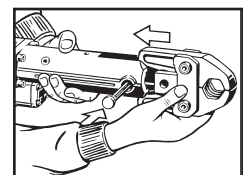

7. Open the jaw and place at right angles on the fitting. Visually check insertion depth using mark on tubing.

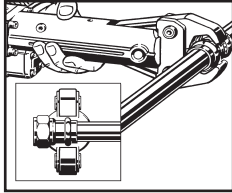

8. Start pressing process and hold the trigger until the jaw has engaged the fitting.

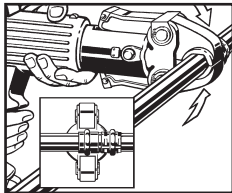

9. After pressing, the jaw can be opened again.

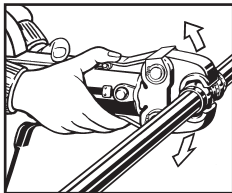

10. For applications requiring ProPress with FKM sealing elements, remove the factory installed EPDM sealing element and replace with FKM sealing element.

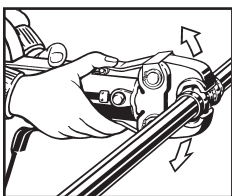

10.7 Seapress 64 mm – 108 mm Installation

 Read, understand and follow all instructions for installing Seapress fittings. Failure to follow all instructions may result in extensive property damage, serious injury, or death.

1. Cut tubing at right angles using displacement type cutter or fine-toothed steel saw.

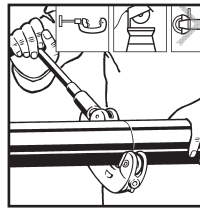

2. Keep end of tubing a minimum of 4" away from the contact area of the vise to prevent possible damage to the tubing in the press area.

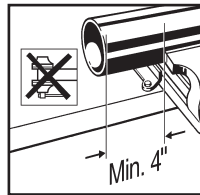

3. Remove burr from inside and outside of tubing to prevent cutting sealing element.

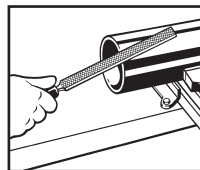

4. Mark proper insertion depth as indicated by the Seapress insertion depth chart. Improper insertion depth may result in an improper seal.

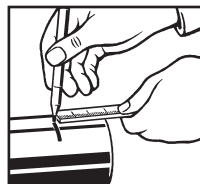

5. Check seal and grip ring for correct fit. Use only ProPress shiny black EPDM sealing elements.

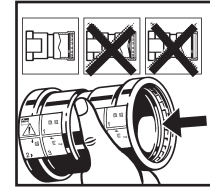

6. Illustration demonstrates proper fit of grip ring, separation ring and sealing element.

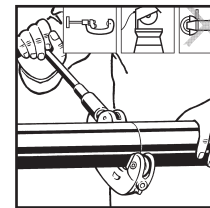

7. While turning slightly, slide press fitting onto tubing to the marked depth. Do not use oils or lubricants.

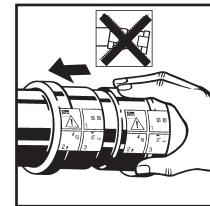

8. Seapress fitting connections must be performed with ProPress XL Rings and V2 ACTUATOR. Use of ProPress XL Rings and/or Actuator (for Bronze fittings) will result in an improper connection. See RIDGID® Operator's Manual for proper tool instructions.

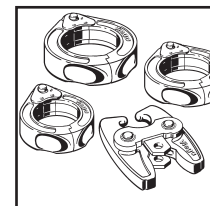

Insertion Depth Chart			
Tube Size (mm)	76	88	108
Insertion Depth (mm)	50	50	65

9. Open XL Ring and place at right angles on the fitting. XL Ring must be engaged on the fitting bead. Check insertion depth.

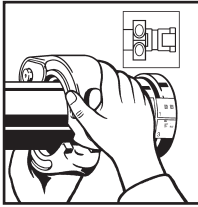

10. With V2 ACTUATOR inserted into the tool, open the V2 ACTUATOR as shown and connect V2 ACTUATOR to the XL Ring.

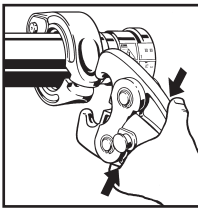

11. Place V2 ACTUATOR onto XL Ring and start pressing process. Hold the trigger until the Actuator has engaged the XL Ring. Keep extremities and foreign objects away from XL Ring and V2 ACTUATOR during pressing operation to prevent injury or incomplete press.

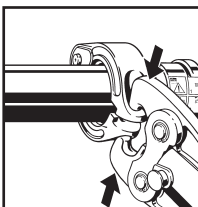

12. Release V2 ACTUATOR from XL Ring and then remove the XL Ring from the fitting on completion of press. Remove tag from fitting, indicating press has been performed.

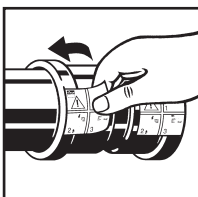

11. SANPRESS INOX (STAINLESS METRIC) PIPE AND FITTINGS 15 MM -108 MM

11.1 Viega Press Systems Pipe

Only Viega Sanpress INOX piping is approved for installation with Sanpress INOX fittings. This is to ensure reliability and conformity with the stainless steel system. Sanpress INOX pipe comes in sizes 15mm through 108mm.

General

Viega Sanpress INOX pipes are schedule 5, inert gas welded pipe, meeting ASTM A776 and DIN 316S.

Delivery Condition

All dimensions of pipe are delivered in sticks that are six meters in length, with a metallic bare exterior and interior surface. The pipes are free from annealing color, corrosion promoting substances and hygienically questionable substances.

All pipes have been tested for leaks. The pipes are subject to continuous monitoring, as well as external monitoring by the material testing office. Viega Press Systems pipes offer these advantages:

- Form-stable
- Prevent fire as no soldering or welding device is required for installation
- Press fitted in seconds
- Low in linear expansion due to heating

Identification

Viega Press Systems stainless pipes are marked and labeled with the following information along their entire length:

1. System vendor/system name
2. Test marks and approval marks
3. Material number in accordance with DIN specifications
4. Pipe diameter x wall thickness
5. Manufacturing type g = inert gas welded
6. Pipe manufacturer abbreviation
7. Manufacturing date
8. Lot or reel number

11.2 Handling Instructions

Sanpress INOX components shall be free from dirt, debris, scaling, or items that may interfere with the sealing element and the press connection. Sanpress INOX sealing elements are to be visually inspected prior to installation to ensure the seal is intact and properly located within the fitting.

11.3 Welding Near Sanpress INOX Fittings

When welding near a Sanpress INOX connection, the installer must remain at least three feet away from the connection to prevent damage to the sealing element. If three feet is not possible, the installer should take precautions to keep the Sanpress INOX connection cool while welding. These include:

- Wrapping the connection with a cold wet rag

- Fabricating welded connections prior to installing the pressed fitting making sure the pipe has cooled before installing the fitting
- Consistently applying "spray type" spot freezing

11.4 Rotating a Pressed Fitting

Once a Sanpress INOX fitting has been pressed it can be rotated (not by hand), but once rotated more than five degrees, the fitting must be re-pressed to restore the resistance to rotational movement.

11.5 Codes and Approvals

American Bureau of Shipping
United States Coast Guard
Lloyd's Register
Det Norske Veritas
Nippon Kaiji Kyokai

11.6 Sanpress INOX 15 mm – 54 mm Installation



Read, understand, and follow all instructions for installing ProPress fittings. Failure to follow all instructions may result in extensive property damage, serious injury, or death.

1. Cut stainless steel piping at right angles using displacement type cutter or fine-toothed steel saw .

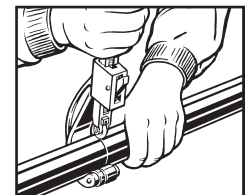

1 System vendor/system name	4 Pipe width exterior diameter x wall thickness	6 Pipe manufacturer abbreviation
2 Test marks and approval marks	5 Manufacturing type g = inert gas welded	7 Manufacturing date
3 Material number in accordance with DIN		8 Lot or reel number

Viega sanpress DVGW TS 233 SVGW ÖVGW VA Avis Technique 15/91-169 ATG 92/1868 1.4401 28x1,2 g Fi 0397 CH: 123456

Identification of Sanpress INOX

2. Debur piping on inside and outside to prevent cutting fitting seal.

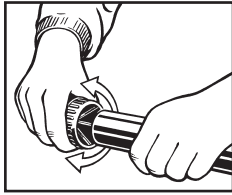

3. Check seal for correct fit. Do not use oils or lubricants. Use only ProPress shiny black EPDM or dull black FKM sealing elements.

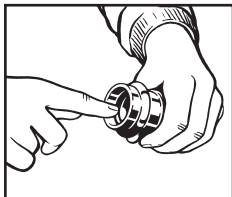

4. While turning slightly, slide press fitting onto piping to the fitting stop. End of tubing must contact stop.

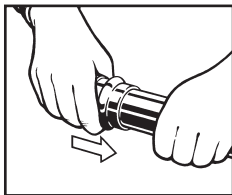

5. Mark insertion depth.

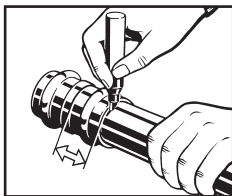

Tube Size (mm)	15	18	22	28	35	42	54
Insertion Depth (mm)	18	22	22	22	25	36	40

6. Insert the appropriate jaw into the pressing tool and push in holding pin until it locks into place.

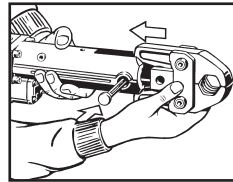

7. Open the jaw and place at right angles on the fitting. Visually check insertion depth using mark on piping.

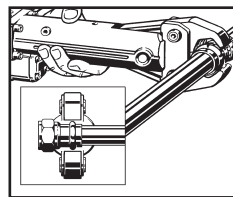

8. Start pressing process and hold the trigger until the jaw has engaged the fitting.

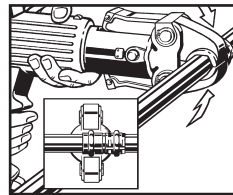

9. After pressing, the jaw can be opened again.

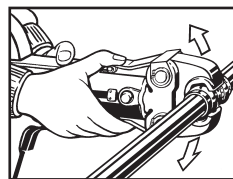

10. For applications requiring Sanpress with FKM sealing elements, remove the factory installed EPDM sealing element and replace with FKM sealing element.

11.7 Sanpress INOX 64 mm – 108 mm Installation



Read, understand and follow all instructions for installing Sanpress fittings. Failure to follow all instructions may result in extensive property damage, serious injury, or death.

1. Cut copper piping at right angles using displacement type cutter or fine-toothed steel saw.

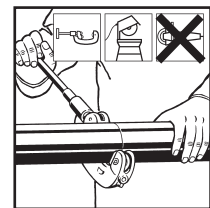

2. Keep end of piping a minimum of 4" away from the contact area of the vise to prevent possible damage to the piping in the press area.

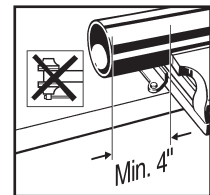

3. Remove burr from inside and outside of piping to prevent cutting sealing element.

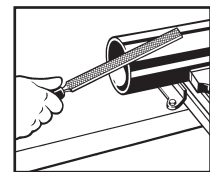

4. Mark proper insertion depth as indicated by the Sanpress INOX insertion depth chart. Improper insertion depth may result in an improper seal.

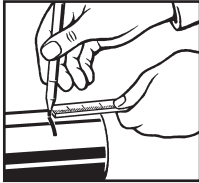

Sanpress XL Insertion Depth Chart				
Tube Size (mm)	64	76	88	108
Insertion Depth (mm)	43	50	50	65

5. Check seal and grip ring for correct fit. Illustration demonstrates proper fit of grip ring, separation ring and sealing element. Use only ProPress shiny black EPDM sealing elements.

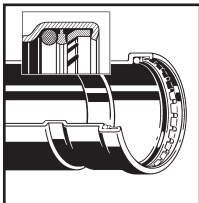

6. While turning slightly, slide press fitting onto piping to the marked depth. Do not use oils or lubricants.

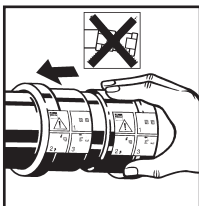

7. Sanpress INOX fitting connections must be performed with ProPress XL Rings and V2 ACTUATOR. Use of ProPress XL Rings and/or Actuator (for Bronze fittings) will result in an improper connection. See RIDGID® Operator's Manual for proper tool instructions.

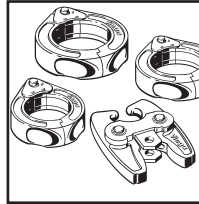

8. Open XL Ring and place at right angles on the fitting. XL Ring must be engaged on the fitting bead. Check insertion depth.

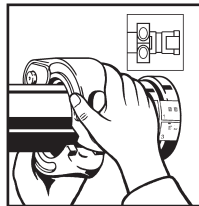

9. With V2 ACTUATOR inserted into the tool, open the V2 ACTUATOR as shown and connect V2 ACTUATOR to the XL Ring.

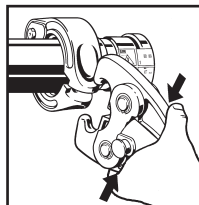

10. Place V2 ACTUATOR onto XL Ring and start pressing process. Hold the trigger until the Actuator has engaged the XL Ring. Keep extremities and foreign objects away from XL Ring and V2 ACTUATOR during pressing operation to prevent injury or incomplete press.

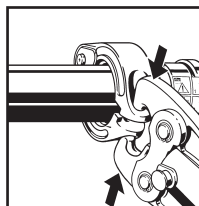

11. Release V2 ACTUATOR from XL Ring and then remove the XL Ring from the fitting on completion of press. Remove elastic control ring from fitting, indicating press has been performed.

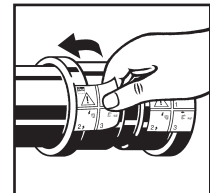

12. PROPRESSG™

12.1 Welcome

By choosing to install a CSA LC-4 approved ProPressG System for natural gas, liquid propane gas, or fuel oil, you have joined the ranks of installing contractors across the country who believe there is no substitute for quality.

Viega and RIDGID® have a history of bringing high quality and innovative technology to the construction marketplace in the United States. As with the companion ProPress System, Viega fittings and RIDGID® tools make it a ProPressG System. Our engineers research and develop complete systems that provide you, our customers, the most effective and easy-to-use products available.

The ProPressG System is a fast, safe and reliable way to install natural gas, liquid propane and fuel oil systems with type K and L copper tubing. It provides the added benefit without flames or brazing while making connections in seconds, keeping projects on time and within budget.

Using an HNBR sealing element designed to last the life of the tubing, the ProPressG System also incorporates the Smart Connect feature. If a connection is left unpressed, leakage of liquids and/or gases from inside the system past the sealing element is assured during pressure testing. The Smart Connect feature is removed during the pressing process creating a leak-free permanent connection. Built to last – fittings are thicker than type K copper and meet the most rigorous testing standards and codes in the United States and Europe.

In the following pages you will be guided through the installation process of the ProPressG System. You will then understand why this is the fastest and most reliable form of fuel gas installation.

12.2 Intent

This publication is intended to provide information and guidance to design and installation professionals with regards to copper tubing systems using ProPressG fittings for fuel oil, natural gas, liquid propane gas and fuel oil piping systems. States and local jurisdictions throughout the United States have adopted either the National Fuel Gas Code (NFPA 54 for Natural Gas, NFPA 58 for LP Gas), the International Fuel Gas Code, or the Uniform Plumbing Code. Local gas utilities may have additional requirements for use within their jurisdictions. Designers and installers of fuel gas piping systems should check with the building department and local gas utilities to identify the code and/or standard regulating fuel gas piping installations within the jurisdiction.

12.3 History

ProPressG has been used in Europe since 1999 and in the U.S. since 2004. (ProPress has been used in Europe since the late 1980s and in the U.S. since the late 1990s for a variety of applications.) Both systems are backed by two plumbing leaders, Viega and the Ridge Tool Company, with a combined excellence of over 175 years.

13. SYSTEM DESCRIPTION

13.1 System Description

ProPressG is a copper press connection system designed to meet the demands of natural gas and liquid propane gas in the vapor state, as well as fuel oil systems. Press fittings are manufactured in copper and bronze and fittings with NPT connections are manufactured in bronze. ProPressG fittings use an HNBR sealing element to provide permanent leak-proof connections in dimensions from 1/2" to 2". All fittings have a built-in Smart Connect Feature. ProPressG may be used up to 125 psi and an ambient temperature range of -40°F – 180°F for CSA approved applications. Consult your local Viega sales representative for additional applications and operating parameters.

13.2 Applications

CSA LC-4 Approved Applications

- Natural Gas
- Liquid Propane Gas
- Mixed Fuel Gases (vapor state only)
- Manufactured Fuel Gases
- Butane

Other Approved Applications

- Fuel Oil Heating Systems
- Carbon Dioxide CO₂ (dry)
- Vacuum 29.2" Mercury
- Diesel Fuel
- Motor Oil

***Note: All systems must be installed per local code requirements.**

13.3 Product Description

Viega ProPressG fittings are currently offered in 120 configurations. Fittings are provided with a factory installed HNBR sealing element, yellow in color. ProPressG fittings must be used with type K or L copper tubing. Hard copper tubing can be used in 1/2" - 2" and soft copper tubing in 1/2" - 1-1/4" diameters. (Note: Local codes generally

prohibit the use of type M copper tubing for use in natural and liquid propane gas piping systems.) All tubing must comply with ASTM B88 standards. ProPressG fittings are approved for installations in above and below ground applications.

Every ProPressG fitting has our patented Smart Connect feature. This feature allows the installer to quickly identify an unpressed connection during pressure testing. A noticeable drop in pressure will occur in testing ranging from 1/2 to 85 psi. All ProPressG systems must be installed per local code requirements.

Viega ProPress products carry a 50-year warranty against defects in material and workmanship. The RIDGID lifetime warranty applies to tools, jaws and press rings from The Ridge Tool Company.

13.4 Advantages

The advantages of installing copper with ProPressG fitting for fuel gas piping systems include:

- Lowest overall installed cost
- CSA LC-4 listed & code approved
- Proven joining technology
- Offers most labor savings
- Lowest flexible piping material cost
- Installs with soft & hard copper
- One tool for gas & water fittings
- No special certification required
- Semi-rigid tubing material
- Lighter than black steel pipe
- Technical field support

13.5 Approvals and Certifications

There are three major codes and standards regulating fuel gas piping systems. They include: The National Fuel Gas Code, also identified as NFPA 54, The ICC International Fuel Gas Code and The IAPMO Uniform Plumbing Code. All three of these codes regulate both natural gas and liquid propane gas piping systems. Type K or L copper tubing is permitted for fuel gas piping systems in National Fuel Gas Code (NFPA 54), the International Fuel Gas Code, or the Uniform

Plumbing Code.

When using copper tubing, each code restricts the amount of hydrogen sulfide permitted in the gas to 0.3 grains of hydrogen sulfide per 100 standard cubic feet of gas (0.7 milligrams per 100 liters). Copper tubing joined by mechanical fittings or by brazed joints is permitted and approved (or listed) for use in fuel gas piping systems. Viega ProPressG fittings have been listed for use in fuel gas piping systems by CSA.

CSA International

- CSA LC-4

International Approvals (Profipress G):

- UPC Chapter 12 Fuel Piping
- Deutsch Verein des Gas-und Wasserfaches E.V. (DVGW)
- ICC PMG - 1036
- Lloyd's Register (LLOYD'S)
- Det Norske Veritas (DNV)
- Registro Italiano Navale (RINA)
- Bureau Veritas (BV)
- KIWA
- CSA - B149.1-05

Compliant with:

- IFGC International Fuel Gas Code
- NFPA 54/Z223.1 National Fuel Gas Code
- NFPA 58 Liquefied Petroleum Gas Code
- UPC Chapter 12 Fuel Piping
- ICC PMG - 1036
- NFPA 30 Flammable and Combustible Liquids Code
- NFPA 30A Code for Motor Fuel Dispensing Facilities and Repair Garages
- NFPA 31 Standard for the Installation of Oil-Burning Equipment (supply line only)

14. PROGRESSG APPLICATIONS

14.1 Fuel Gas Systems

All ProPressG fittings have a factory installed HNBR sealing element that can be installed in ambient temperature ranges from -40°F (-40°C) to 180°F (82°C) and a maximum operating pressure of 125 psi (8.6 bar), making them suitable for many applications. ProPressG fittings are approved for installations in above and below ground applications.

Applications include:

- Natural Gas
- Liquid Propane Gas
- Mixed Fuel Gases (vapor state only)
- Manufactured Fuel Gases
- Butane
- Fuel Oil Heating Systems
- Carbon Dioxide CO₂ (dry)
- Vacuum 29.2" Mercury
- Diesel Fuel
- Motor Oil

Note: All systems must be installed per local code requirements.

ProPressG is ideal for fuel gas applications due to its excellent resistance to corrosion, as well as its ease of handling and installation. Copper has provided reliable service for several decades and offers effective solutions to today's technological challenges.

Note: Consult the Viega Technical support department before installing the system in other applications or applications with temperatures and/or pressures outside the stated ratings.

14.2 Natural Gas/LP Gas Systems

Because there are a vast number of known natural and liquid propane applications and new ones being discovered, it would be impossible to list them all. Natural gas and liquid propane gas piping systems are commonly utilized in residential, commercial and industrial applications. The uses described here are intended to help depict some of the applications for ProPressG.

Residential Applications

Residential uses of natural gas and liquid propane gas include furnaces, boilers, water heaters, gas dryers, fireplaces, kitchen ranges, grills, lighting, as well as many others.

Commercial Applications

Commercial uses of natural gas and liquid propane gas are very similar to residential uses. The commercial sector includes public and private enterprises, such as office buildings, schools, churches, hotels, restaurants and government buildings.

The main uses of natural gas and liquid propane gas in this sector include space heating, water heating and cooling. For restaurants and other establishments that require cooking facilities, natural gas and liquid propane gas are popular choices to fulfill these needs.

Industrial Applications

Natural gas and liquid propane gas have a multitude of industrial uses including providing the base ingredients for such varied products as plastic, fertilizer, antifreeze and fabrics. In fact, this industry is the largest consumer of natural gas accounting for 43% of natural gas use across all sectors. Natural gas is the second most used energy source in industry, second to electricity.

14.3 Mixed Gases

Gas mixtures are used for a variety of applications. Due to the vast array of mixed gases, listed below are the most common applications. Compatibility with specific mixtures must be approved by Viega.

Welding Gases

Various mixtures are used as shield gases in many gas metal arc welding methods. The most common mixture is argon and carbon dioxide.

Plasma-arc cutting and plasma-arc welding employ plasma gas (argon and hydrogen) to provide a very high temperature when used with a special torch.

Calibration Gases

Calibration gases comprise the largest of the two groups. Their main function is to calibrate analytical equipment. These mixes contain reactive components at trace levels.

Process Gas Mixtures

Process gas mixtures are either a component of a manufacturing process or of a manufactured product. Applications range from leak detection, to the production of sealed products, such as sealed lamps.

14.4 Fuel Oil Systems

There are a variety of uses for ProPressG in fuel oil piping systems. Applications include fill and vent lines, storage tanks, feed lines connecting storage tanks, burners, as well as many others.

15. PRODUCT DESCRIPTION

15.1 Fittings

Viega ProPressG Fittings are currently offered in more than 120 fitting configurations. ProPressG fittings are manufactured in copper and bronze and are available in sizes ranging from 1/2" to 2". Every fitting is provided with a factory installed HNBR sealing element. In addition, all fittings include our patented Smart Connect feature.

Fitting Benefits:

- Smart Connect feature
- Precise tolerances
- Integral stop for insertion depth
- Factory installed sealing element

Since ProPressG fittings are available in sizes 1/2" – 2", ProPressG can be used in a wide variety of residential and commercial fuel gas piping applications. The tubing and the ProPressG fittings are rated for 125 psi fuel gas pressure. Because of this rating, the material can be used for low pressure, 0.5 psi, to very high pressure, 125 psi.

In commercial construction it is common to have 2 psi gas in a building running to appliances. This reduces the size of the copper tubing required for fuel gas piping systems.

Each fitting is marked with the following:

- Viega
- The fitting dimension
- CSA logo and max pressure



15.2 HNBR Sealing Element

Every ProPressG fitting includes a factory installed HNBR sealing element. HNBR stands for Hydrogenated Nitrile Butadiene Rubber, which is yellow in color. This sealing element is used mainly for applications of natural gas, propane, mixed and manufactured gases in the vapor state, not in the liquid state. It is also commonly used in fuel oil heating systems.

The operating temperature for HNBR is -40°F to 180°F. It is known for its physical strength and retention of properties after long-term exposure to heat, oil and chemicals. The unique properties attributed to HNBR have resulted in wide adoption of HNBR in automotive, industrial and assorted performance-demanding applications. With its excellent performance for the most demanding of applications, HNBR is the ideal choice for applications needing excellent physical properties, as well as oil, heat and/or chemical resistance.

The HNBR sealing element is not suitable for food contact or drinking water applications.

15.3 Copper Tubing

ProPressG fuel gas installations can be made with seamless, corrosion resistant drawn copper tubing. These tubes must comply with the requirements of ASTM B88.

Table 15.3 identifies the different types of copper tube allowable for use in ProPressG fuel gas distribution systems, as well as the identification and availability of each type. Types K and L copper tube (ASTM B 88) have been used in fuel gas systems for many years. Type L is typically used for interior distribution systems and type K for any underground lines.

The dimensions of copper tube used for gas installations are shown in Table 15.3. Tube and fittings in fuel gas systems are usually identified by their outside diameter (O.D.) rather than their nominal sizes.

Table 15.2: ProPressG product line general overview

<p>Elbows Used to change direction 45° and 90°</p>	
<p>Threaded Adapters Used to connect other piping materials and system components (i.e. meters, valves, etc.)</p>	
<p>Tees Used for branch piping connections</p>	
<p>Couplings and reducing couplings Used for connecting tubing and reducing tubing diameter</p>	

Designers and installers should be specific with size designations in their references and when ordering. Copper and copper alloy tube should not be used if the gas contains more than an average of 0.3 grains of hydrogen sulfide per 100 standard cubic feet (scf) of gas (0.7 mg/100 L). Today, federal regulations limit the amount of hydrogen sulfide allowed in natural gas transmission. The allowable limits are below those specified in the model codes and below the amounts that would adversely affect copper tubing. Copper tubing can be installed in all areas of construction, including concealed spaces.

For underground applications, copper tubing can be installed below ground, as ProPressG and copper tubing is approved for underground installations.

However, any installations must meet all state and local codes, including those for underground. Proper authorization must be obtained prior to underground installation. ProPressG and copper tubing may be installed outside without any additional corrosion protection.

In residential applications, copper tubing with ProPressG fittings can be used to run fuel gas from the meter or source, to furnaces, boilers, gas ranges, water heaters, gas fireplaces, clothes dryers, outdoor barbecues and decorative lighting. Copper tubing is available in long lengths, reducing the number of fittings required.

Copper tubing can be easily installed in wall and floor cavities. When retrofitting an installation in a home, copper tubing using ProPressG fittings is easier, faster and less expensive than installing threaded steel pipe or CSST.

For commercial construction, copper tubing using ProPressG fittings may be installed for gas lines to air handling units, boilers, water heaters and other appliances. For rooftop installations, copper tubing with ProPressG fittings can be installed either on or below the roof. When installed on the roof, the copper tubing does not have to be coated or covered since the material is corrosion resistant.

15.4 Pressing Process Overview

The Smart Connect Feature

The Smart Connect feature is a special indentation in the inside surface of the fitting near the sealing element. This indentation assures identification of leakage of liquids and/or gases from inside the system past the sealing element of an unpressed connection. The indentation is removed during the pressing process creating a leak-proof, permanent connection. This feature provides quick and easy identification of connections that have not been pressed prior to putting the system into operation. Unpressed connections are located by pressurizing the tubing system with a maximum pressure range of

Table 15.4: Wall thickness of copper tubing (ASTM B 88)

Nominal or Standard Size	Nominal OD	Nominal Wall Thickness	
		Type K	Type L
1/2"	0.625	0.049	0.040
3/4"	0.875	0.065	0.045
1"	1.125	0.065	0.050
1-1/4"	1.375	0.065	0.055
1-1/2"	1.625	0.072	0.060
2"	2.125	0.083	0.070

Table 15.3: Technical data and product range

Tube Type	Color Code	Standard	Typical Application	Nominal or Standard Sizes	Drawn	Annealed	
Type K	Green	ASTM B 88	Potable Water, HVAC, Solar Systems, Chilled Water, Fire Sprinkler, Compressed Air, Natural Gas, LP Gas, Fuel Oil	Straight Lengths			
				1/2" to 2"	20 ft.	20 ft.	
				Coils			
				1/2" to 1"		60 ft.	
				1-1/4" to 1-1/2"		100 ft.	
				2"		60 ft.	
Type L	Blue	ASTM B 88	Potable Water, HVAC, Solar Systems, Chilled Water, Fire Sprinkler, Compressed Air, Natural Gas, LP Gas, Fuel Oil	Straight Lengths			
				1/2" to 2"	20 ft.	20 ft.	
				Coils			
				1/2" to 1"		60 ft.	
				1-1/4" to 1-1/2"		100 ft.	
				2"		60 ft.	
Type M*	Red	ASTM B 88	Potable Water, HVAC, Solar Systems, Chilled Water, Fire Sprinkler, Compressed Air, Fuel Oil	Straight Lengths			
				1/2" to 2"	20 ft.	20 ft.	
				Coils			
				1/2" to 1"		60 ft.	
				1-1/4" to 1-1/2"		100 ft.	
				2"		60 ft.	
					40 ft.		
						45 ft.	

*Type M copper tubing may be installed in fuel oil systems but is commonly not allowed for natural and liquid propane gas systems. Consult local codes prior to the installation of ProPressG fittings.

1/2 - 85 psi.

The Smart Connect feature test is not a substitute for local code required pressure testing. The final pressure test is to be carried out in



Figure 15.1: Smart Connect feature in ProPressG 1/2" to 2" fittings.

accordance with local codes.

15.5 Press Connections

The pressing process provides a simple, safe and reliable means of connecting copper tubing for fuel gas systems with ProPressG fittings as shown in figure 15.2.

Figure 15.2 ProPressG connection for 1/2" to 2" before and after the pressing process.

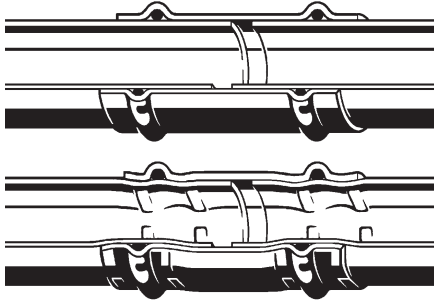

15.6 The Connection Process

The pressing process produces a permanent joint between the press fitting and the tubing in a matter of seconds. For ProPressG fittings 1/2" to 2", this is achieved by creating a hexagonal indentation in front of and behind the HNBR sealing element on the press fitting. At the same time, the pressing process reshapes the fitting to encapsulate the sealing element (Fig. 15.3). This technology ensures a permanent connection.

Figure 15.3: Cross-section through a ProPressG connection after pressing

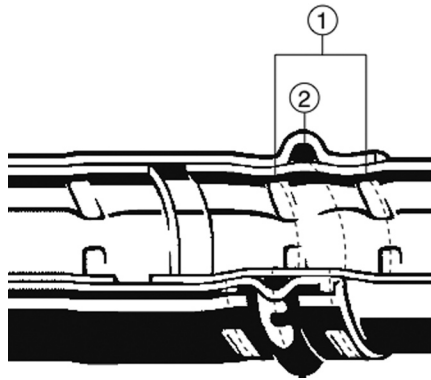

ICC-ES PMG Listing**PMG-1036***Effective Date: July 1, 2009**This listing is subject to re-examination in one year.*

www.icc-es.org/pmg | (800) 423-6587 | (562) 699-0543 *A Subsidiary of the International Code Council®*

CSI: DIVISION: 15—MECHANICAL
 Section: 15190—Fuel Piping

Products: Viega LLC's ProPressG System: Press-connect copper and copper alloy fittings for fuel gas distribution systems.

Listee: Viega LLC
 301 North Main Street, Floor 9
 Wichita, Kansas 67202
 www.viega.com

Compliance with the following codes:

2006 *International Fuel Gas Code*® (2006 IFGC)
2006 *International Residential Code*® (2006 IRC)
2006 *IAPMO Uniform Plumbing Code*® (2006 IAPMO UPC)
2009 *International Fuel Gas Code*® (IFGC)
2009 *International Residential Code*® (IRC)
2009 *IAPMO Uniform Plumbing Code*® (IAPMO UPC)

Compliance with the following standards:

ASTM B 88-03, Standard Specification for Seamless Copper Water Tube
ANSI LC 4-07, Press-connect Copper and Copper Alloy Fittings for Use in Fuel Gas Distribution Systems

Identification:

Fittings: The Viega LLC ProPressG fittings must bear a permanent marking with the following information:

- Manufacturer's name or trademark (Viega).
- Nominal size corresponding to the copper tube size.
- Date of manufacture (date code or batch code).
- Maximum specified operating pressure.
- Color identification: yellow (for fuel gas only).
- Mark of the third-party inspection agency (CSA International, AA-659).

Packages of fittings must bear the manufacturer's name (Viega LLC), product name (ProPressG), model number and the ICC-ES PMG listing mark. The ICC-ES listing number (PMG-1036) is optional.

Installation:

Viega ProPressG fittings must be installed in accordance with this listing, the applicable code and the manufacturer's published installation instructions. The manufacturer's published installation

Listings are not to be construed as representing aesthetics or any other attributes not specifically addressed, nor are they to be construed as an endorsement of the subject of the listing or a recommendation for its use. There is no warranty by ICC Evaluation Service, Inc., express or implied, as to any finding or other matter in this listing, or as to any product covered by the listing.



instructions must be furnished to the code official. Installation is subject to approval by the code official having jurisdiction.

Models: Fittings:

The Viega ProPressG fittings are available in sizes from 1/2 inch (13 mm) to 2 inches (51 mm). Viega ProPressG fittings are rated for a maximum operating pressure of 125 pounds per square inch gauge (psig) (34 kPa gauge). Each fitting is available in copper or copper alloy and is provided with a factory-installed HNBR (hydrogenated nitrile butadiene rubber) sealing element. All fittings have a built-in Smart Connect (SC) feature. The function of the SC feature is to identify connections which have not been pressed.

	DESCRIPTION	SIZE RANGE
ADAPTOR	Bronze Male Adaptors: C x M NPT	1/2" to 2"
	Bronze Female Adaptors: C x F NPT	1/2" to 2"
	Bronze Female Adaptors: FTG x F NPT	1/2" to 2"
	Bronze Male Adaptors: FTG x M NPT	1/2" to 2"
CAP	Copper Caps	1/2" to 2"
COUPLING	Copper Couplings with Stop: C x C	1/2" to 2"
	Copper Coupling w/o Stop: C x C	1/2" to 2"
ELBOW	Copper Elbow 90 degrees: C x C	1/2" to 2"
	Copper Elbow 90 degrees: FTG x C	1/2" to 2"
	Copper Elbow 90 degrees: C x M NPT	1/2" to 2"
	Copper Elbow 45 degrees: C x C	1/2" to 2"
	Copper Elbow 45 degrees: FTG x C	1/2" to 2"
FITTING REDUCER	Copper Reducer: FTG x C	1/2" to 2"
	Copper Reducer: C x C	1/2" to 2"
TEE	Copper Tee: C x C x C	1/2" to 2"
MANIFOLD	Copper Manifold Tee: C x FTG x C	1/2" to 2"
	Copper Manifold: 3 Outlet, C x FTG x C	1" x 1" x 1/2"
UNION	Bronze Union: C x M NPT	1/2" to 2"
	Bronze Union: C x C	1/2" to 2"
BALL VALVE	Ball Valve (SC)	1/2" to 2"

For SI: 1 inch = 25.4 mm.

Conditions of Listing:

1. In accordance with IFGC Section 402.6 and UPC Section 1211.5, the maximum design operating pressure for piping systems located inside buildings must not exceed 5 psig (34 kPa gauge) except where at least one of the following conditions is met:
 - a. The piping system is welded.
 - b. The piping is located in a ventilated chase or otherwise enclosed for protection against accidental gas accumulation.
 - c. The piping is located inside buildings or in separate areas of buildings used exclusively for:
 - i. Industrial processing or heating.

- ii. Research.
 - iii. Warehousing.
 - iv. Boiler or mechanical rooms.
 - d. The piping is a temporary installation for buildings under construction.
 - e. The piping serves appliances or equipment used for agricultural purposes.
 - f. The piping system is an LP-gas piping system with design operating pressure greater than 20 psi (137.9 kPa), and complies with NFPA 58 (IFGC) or NFPA 54 (UPC).
2. When piping is installed in vertical chases under the UBC, the gas piping exceeding 5 psig (34 kPa) must be installed in accordance with UBC Section 1211.4.
3. Fittings are for use with ASTM B 88, Type L or Type K, copper only.
4. Operating temperature range must be within minus 40°F to plus 180°F (minus 40°C to plus 82.2°C).
5. The fittings have not been evaluated for use when embedded in a solid material such as concrete.
6. The fitting installation must be pressure-tested for leaks in the presence of the code official or the official's designated representative in accordance with the applicable code.
7. The fittings are manufactured in Grossheringen, Germany, and Ennest, Germany, under a quality control program with one surveillance inspection per year by NSF International (AA-633).



Certificate of Compliance

Certificate:	1534123	Master Contract:	205817
Project:	1946686	Date Issued:	2007/11/14
Issued to:	Viega LLC Plumbing and Heating Systems 301 North Main, Suite 900 Wichita, KS 61202 USA Attention: Andrew C. Granzow		

The products listed below are eligible to bear the CSA Mark shown with adjacent indicator 'US'



Issued by: James Sekerak

Authorized by: Trevor Perera, Manager of Certification Services

Trevor Perera

PRODUCTS

CLASS 3305 91 - GAS ACCESSORY DEVICES - Press - Connect Type Copper Fittings
 Certified to US Standards

Adapters 0611, 0612

Couplings 0615

90° Elbow 0616, 0616.1

45° Elbow 0626, 0626.1,

The 'US' indicator adjacent to the CSA Mark signifies that the product has been evaluated to the applicable ANSI/UL Standards, for use in the U.S.. This 'US' indicator includes products eligible to bear the 'NRTL' indicator. NRTL, i.e. National Recognized Testing Laboratory, is a designation granted by the U.S. Occupational Safety and Health Administration (OSHA) to laboratories which have been recognized to perform certification to U.S. Standards.



Certificate: 1534123

Master Contract: 205817

Project: 1946686

Date Issued: 2007/11/14

Tee 0618,

Manifold Tee 0618.1

Press-fit Ball Valve

ProPress-G*, Rated Pressure: 125 psi, Sizes: 1/2, 3/4, 1, 1-1/4, 1-1/2, 2

*For operation at ambient temperatures of -40°F to 180°F.

PP Manifold 0645,

Cap 0656

Reducer 0615.1,

Unions 0650, 0654,

APPLICABLE REQUIREMENTS

ANSI LC 4 January 29,2007 - American National Standard/CSA Standard for LC 4 Press-Connect Copper and Copper Alloy Fittings for use with Fuel Gas Distribution Systems

MARKINGS

The fittings shall be mechanically stamped or cast unless otherwise noted as follows:

1. Manufacturer's Name VIEGA, ProfiPress-G, and/or ProPress-G
2. Fitting Identification: Nominal size (1/2, 3/4, 1, 1 1/4, 1 1/2 or 2)
3. Date of Manufacture (Date Code): Manufacturer uses a Batch code. See Appendix 'C' for details of plan. .



Certificate: 1534123

Master Contract: 205817

Project: 1946686

Date Issued: 2007/11/14

- 4. Maximum Specified operating pressure 125G
- 5. Color Identification Yellow (indicating Fuel Gas use)
- 6. CSA Monogram with U.S. indicator



April 16, 2004

Mr. Michael Gillespie
Director Technical Services
Viega Inc.
3 Alfred Circle
Bedford, MA 01730

Subject: Viega ProPress-G press connect fitting for use in Concealed Locations

Dear Mr. Gillespie:

This is to confirm that the subject fittings were evaluated to the constructional and performance criteria in the CSA requirement No. 1-02 and was found acceptable. The specific performance tests conducted to evaluate the fittings for use in concealed locations were:

- a) Resistance to Loosening (Vibration) - section 2.8
- b) Resistance to Extreme Temperature Cycles – section 2.9
- c) Resistance to Freezing and Thawing – section 2.10
- d) Torsion – section 2.5
- e) Axial Strength – section 2.4

Please refer to construction sections 1.1.7, 1.3.6 and the definitions in part IV of the requirement No. 1-02 for details. If you have questions please contact me at 216-524-4990 ext. 8277

Sincerely,

Trevor Pereira
Manager Certification Services
CSA International
Cleveland, OH 44131

cc. Andrew Granzow – Viega Inc.



Certificate of Compliance

Certificate: 1534123 **Master Contract:** 205817
Project: 2022743 **Date Issued:** 2008/05/21
Issued to: Viega LLC
 Plumbing and Heating Systems
 301 North Main, Suite 900
 Wichita, KS 67202
 USA
 Attention: Andrew C. Granzow

The products listed below are eligible to bear the CSA Mark shown with adjacent indicators 'C' and 'US'



Issued by: James J. Horvath, PE

Authorized by: Trevor Perera, Manager of Certification Services

Trevor Perera

PRODUCTS

CLASS 3305 11 - GAS ACCESSORY DEVICES - Press Connect Type Copper Fittings
CLASS 3305 91 - GAS ACCESSORY DEVICES - Press - Connect Type Copper Fittings
 Certified to US Standards

Adaptors: 16093, 16078, 23363, 23358, 23368, 16083, 16088, 16058, 16048, 16043, 16068, 16063, 16073, 16053, 23253, 23238, 23263, 23258, 23268, 23248, 23243, 23218, 23203, 23228, 23223, 23233, 23213, 23208,

90° Elbow 17668, 17658, 17678, 17673, 17683, 17663, 16138, 16128, 16148, 16143, 16153, 16133, 16168, 16158, 16178, 16173, 16183, 16163

The 'C' and 'US' indicators adjacent to the CSA Mark signify that the product has been evaluated to the applicable CSA and ANSI/UL Standards, for use in Canada and the U.S., respectively. This 'US' indicator includes products eligible to bear the 'NRTL' indicator. NRTL, i.e. National Recognized Testing Laboratory, is a designation granted by the U.S. Occupational Safety and Health Administration (OSHA) to laboratories which have been recognized to perform certification to U.S. Standards.



Certificate: 1534123

Master Contract: 205817

Project: 2022743

Date Issued: 2008/05/21

45°Elbow 16198, 16188, 16208, 16203, 16213, 16193, 16228, 16218, 16238, 16233, 16243, 16223

Unions 17608, 17598, 17618, 17613, 17623, 17603, 17638, 17628, 17648, 17643, 17653, 17633,

Caps 16323, 16313, 16333, 16328, 16338, 16318,

Couplings 16108, 16098, 16118, 16113, 16123, 16103,

Non Stop Couplings 16091, 16097, 16096,

Manifold Tee and Outlet 16388, 18448, 16393, 16398, 18453

Reducers 23303, 23298, 23288, 23293, 23308, 23278, 23283, 23313, 23273, 16348, 16353, 16363, 16368, 16358, 16373, 16383, 16378, 16343

Tees 16263, 17688, 16273, 23333, 16268, 16248, 16288, 16293, 16298, 23348, 16278, 16283, 16303, 16308, 23353, 16253, 16258

Ball Valves 19663, 19658, 19648, 19668, 19673, 19653

ProPress-G* Rated Pressure: 125 psi Sizes: 1/2, 3/4, 1, 1-1/4, 1-1/2, 2

*For Operation at ambient Temperatures of -40°F to 180°F

APPLICABLE REQUIREMENTS

ANSI LC 4•CSA 6.32-2007 for Press Connect Copper and Copper Alloy Fittings for use with Fuel Gas Distribution Systems

MARKINGS

The fittings shall be laser engraved unless otherwise noted as follows:

1. Manufacturer's Name VIEGA, ProfiPress-G, and/or ProPress-G
2. Fitting Identification: Nominal size (1/2, 3/4, 1, 1 1/4, 1 1/2 or 2)
3. Date of Manufacture (Date Code): Manufacturer uses a Batch code. See Appendix 'C' for details of plan. .
4. Maximum Specified operating pressure 125G
5. Color Identification Yellow (indicating Fuel Gas use)
6. CSA Monogram with C and U.S. indicator



Supplement to Certificate of Compliance

Certificate: 1534123

Master Contract: 205817

The products listed, including the latest revision described below, are eligible to be marked in accordance with the referenced Certificate.

Product Certification History

Project	Date	Description
2022743	2008/05/21	Update to harmonized standard and add certification for Canada add part numbes for the press fit Ball Vavles Replaced figure 4 include new part numbers Added figures 141 to 238
1946686	2007/11/14	Update certificate to ANSI LC4.
1755361	2006/01/24	Addition of ProPress-G press-fit valves.
1534123	2004/04/13	Original Certification - CSA-US certification to CSA requirement No. 1-02, previously tested under project No. 1470025.

16. INSTALLATION REQUIREMENTS

16.1 Clearance Requirements

Minimum clearance requirements for the pressing process

The minimum clearance required between two tubes and between the tubing and any permanent structure must be taken into consideration. The minimum allowable values are specified in Tables 16.1 and 16.2.

Minimum clearance requirements for the pressing process in front of and behind structural components

When press connections are performed directly in front of or behind penetrations in walls/floors, adequate space must be available for the RIDGID pressing tools. The minimum space requirements are listed in Table 16.3.

Minimum clearance between two press connections

To ensure proper sealing of the press connections, the minimum spacing between press connections must be maintained (see Table 16.4).

Note: For installations where the minimum distance is 0, it is particularly important to ensure the correct insertion depth of the tubing into each fitting.

Table 16.1: Space requirements for press jaws between tubes

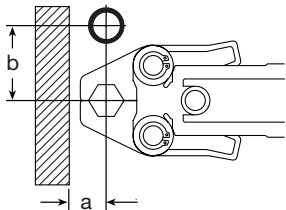

Tube O.D.	A	B
∅	inch (mm)	inch (mm)
1/2"	3/4 (19)	1-5/8 (41)
3/4"	7/8 (22)	2-1/8 (54)
1"	1 (26)	2-1/2 (64)
1-1/4"	1-1/8 (29)	2-7/8 (73)
1-1/2"	1-3/4 (45)	3-1/2 (89)
2"	2 (51)	4-3/8 (111)

Table 16.2: Space requirements for press jaws between pipe and wall/floor structure

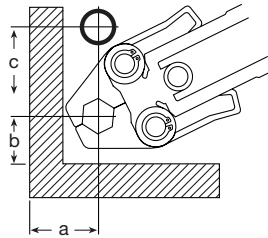

Tube O.D.	A	B	C
∅	inch (mm)	inch (mm)	inch (mm)
1/2"	7/8 (22)	1-3/8 (35)	2-1/2 (64)
3/4"	1 (26)	1-1/2 (38)	2-1/2 (64)
1"	1-1/8 (29)	1-3/4 (45)	3 (76)
1-1/4"	1-1/4 (32)	2-1/4 (73)	3-1/8 (80)
1-1/2"	1-7/4 (48)	2-1/2 (64)	3-3/4 (95)
2"	2-1/8 (54)	3-1/8 (80)	5 (127)

Table 16.3: Space requirements for press tools when making connections in front of/behind penetrations in walls/floors

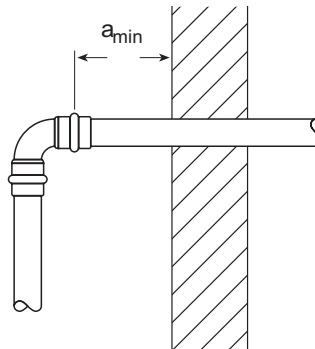

Tube Size	Minimum space requirement, a _{min} for press tools	
	CT400 Press Tool inch (mm)	320-E Battery Press Tool inch (mm)
1/2" to 2"	1-3/4 (45)	2 (50)

Table 16.4: Minimum spacing between press connections

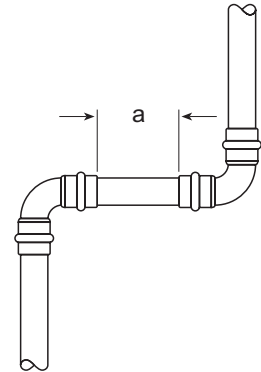

Outer Diameter (inch)	Minimum clearance a inch (mm)
1/2	0 (0)
3/4	0 (0)
1	0 (0)
1-1/4	7/16 (11)
1-1/2	5/8 (16)
2	3/4 (19)

16.2 Protection of Tubing

When copper tubing for fuel gas piping systems is run through studs or joists, the tubing must be protected from the possibility of an inadvertent nail puncture when the tubing is located within 1-3/4" of the finished wall. See Figure 16.1 for more information. Safety plates must be a minimum of 18 gauge in thickness and must be installed to protect the tubing from punctures. Safety plates are premanufactured and available from various companies. Copper tubing installed vertically through partition walls must not be supported within the wall space except at the floor or ceiling.

Safety plates must be AGA approved striker plates of steel pipe of at least .0508" thick and extended a minimum of 4" beyond concealed penetrations of floor/ceiling. Plates must be installed to protect the tubing.

Tubing installed at right angles or diagonal to the joists may be installed through holes drilled through the center of the joists. These holes must be a minimum of 1-1/2 times the O.D. of the tubing. See Table 16.5 for more information. This is to permit the movement of the appliance.

When connecting a copper tubing fuel gas piping system to a steel pipe, cast bronze ProPressG fittings must be used. These bronze fittings provide protection from galvanic action.

16.3 Appliance Stub Out

Appliance stub outs are created by the installer using standard ProPressG fittings. The assembly is attached to a stud using standard tubing hangers for structural support. This provides a fixed point to attach a shut-off valve and flexible appliance connector. Stub out between floor and ceiling must be supported and protected.

Copper tubing may connect directly to appliances that do not vibrate and are not portable. For example, copper tubing can connect directly to a furnace, boiler, or water heater. For connections to dryers or stoves, a flexible connector must be installed between the copper tubing and the appliance. A gas shut-off valve is required to be located within 6 feet of the appliance served. A union fitting must be installed between the shut-off valve and the appliance.

16.4 Tubing Hangers

Tubing hangers perform two functions. The first function is to provide support for the tubing system. The second function is to guide the tubing during expansion and contraction changes in the length of the tubing due to changes in temperature. Standard tubing clamps can be used to support the tubing.

Table 16.6 specifies standard hanger spacing. There are two main types of hangers. One type is a rigid hanger used to secure the tubing and not allow movement in any direction. The other type is a sliding hanger.

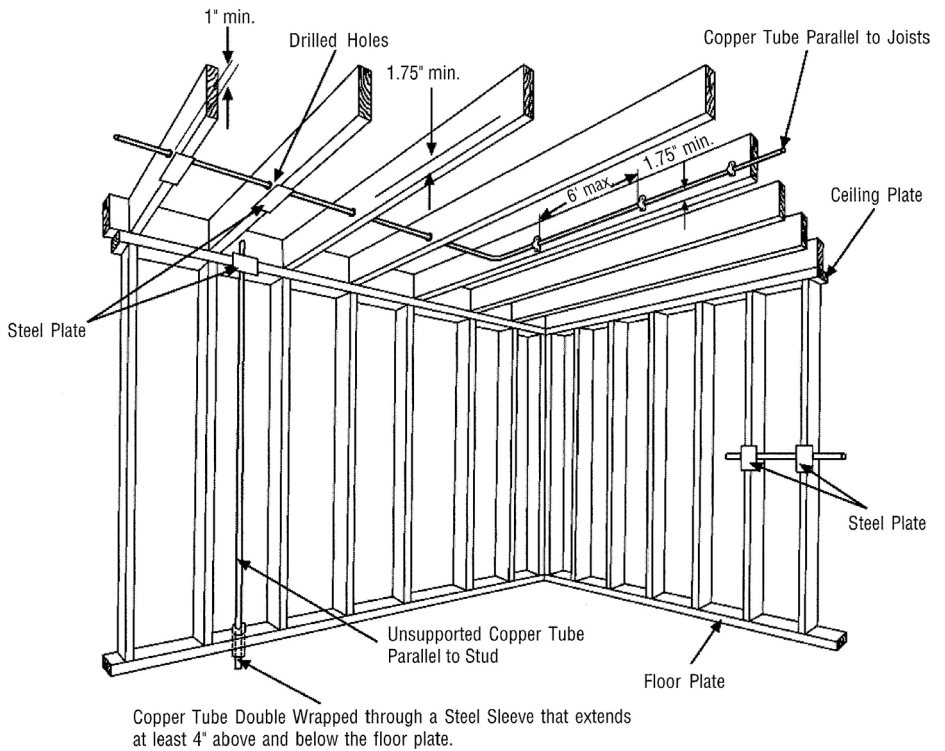

Table 16.5 Minimum drill hole dimensions

Minimum Hole Dimensions		
Tubing Size	OD	Hole Size
1/2"	5/8"	1"
3/4"	7/8"	1-3/8"
1"	1-1/8"	1-3/4"
1-1/4"	1-1/2"	2-1/4"
1-1/2"	1-5/8"	2-1/2"
2"	2-1/8"	3-1/4"

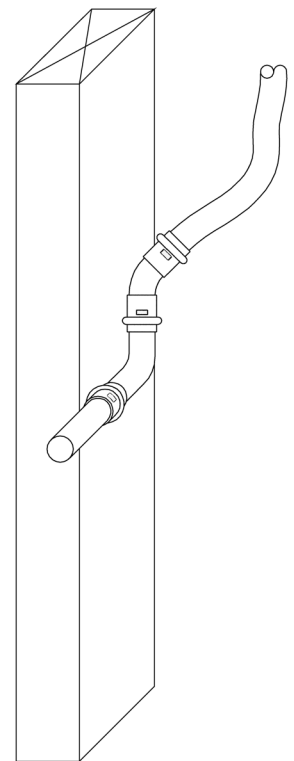

Figure 16.1: Typical appliance stub out

This type of hanger allows axial movement of the tubing. However, all systems must be installed per local code requirements.

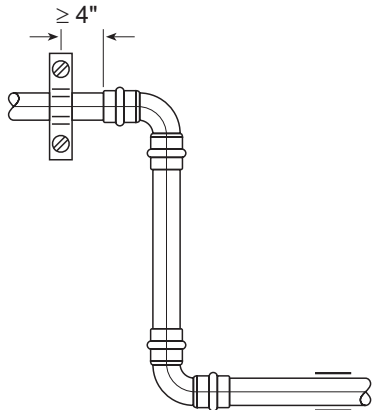

Figure 16.2: Spacing for sliding tube hanger

Tubing should be supported with pipe hooks, metal pipe straps, bands, brackets, or hangers suitable for the size of tubing. Tubing supports should be located at intervals to prevent or damp out excessive vibration. When connecting to equipment, tubing should be anchored to prevent undue strains on connection. Tubing cannot be supported by other tubing.

Hangers and supports must conform to the requirements of ANSI/MSSP 58, pipe hangers and supports, materials, design and manufacture. Supports, hangers and anchors are to be installed in a manner that does not interfere with the free expansion and contraction

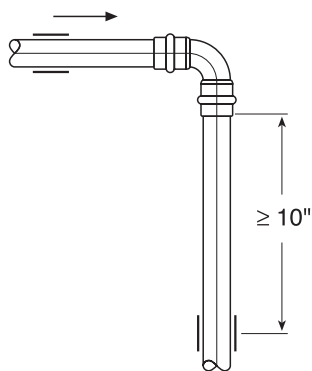

Figure 16.3: Spacing for sliding tube hanger

of the tubing. All parts of the support equipment need to be designed and installed, not to disengage by movement of the supported tubing.

Sliding hangers must be positioned so that they cannot unintentionally become rigid hangers when the system is in use. Fig. 16.3 shows a sliding tubing hanger that becomes a rigid hanger with spacing in excess of 10".

Table 16.6: Hanger Spacing

Nominal Tube Size (Inches)	Copper Tube Max. Span (Feet)	Min. Rod Diameter (Inches)
Up to 3/4	5	3/8
1	6	3/8
1-1/4	7	3/8
1-1/2	8	3/8
2	8	3/8

16.5 Cutting Tubing

Copper tubing can be cut to length with a tubing cutter or a fine-toothed metal saw. It is not acceptable to cut the tubing with an abrasive cutting wheel or torch. The tubing ends must be deburred both on the inside and outside prior to insertion into the press fitting.

16.6 Threaded Adapter

Copper tubing can be cut to length with a tubing cutter or a fine-toothed metal saw. It is not acceptable to cut the tubing with an abrasive cutting wheel or torch. The tubing ends must be deburred both on the inside and outside prior to insertion into the press fitting. The threaded end should be attached before the press end.

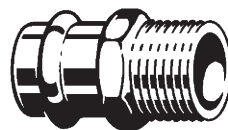

Figure 16.4: Threaded Adapter

16.7 Pressure Testing

The pressure testing of installed tubing is to be completed in accordance with local codes or in the absence of local codes in accordance with NFPA 54 or NFPA 58 respectively.

16.8 Tubing Exposed to Freezing Temperatures

In fuel gas systems, ProPressG can be installed in ambient temperatures down to -40° F.

16.9 Concealed Spaces

ProPressG has been examined to the constructional and performance criteria in the CSA requirement LC-4 and was found acceptable. Specific performance tests were conducted to evaluate the fittings for use in concealed locations. See pages 36 through 42.

16.10 Underground Installations

ProPressG and copper tubing is approved for underground installations. However, any installations must meet all state and local codes, including those for underground.

Proper authorization must be obtained prior to underground installation.

16.11 Identification

Copper tubing for gas service must be continuously marked in order to ensure that it is not mistaken for any other type of service. This is a very important safety measure that must always be completed before introducing gas into the system. This marking, however, is not required for the tubing in the room in which gas-fired appliances are located. Copper tubing is available from some manufacturers with a yellow covering indicating that the tubing is gas tubing. Labels are also readily available and can be added to the tubing indicating that the system is a fuel gas piping system. See Table 16.7 pipe marking guide.

Specific identification must meet the requirements of the applicable local codes. Each system, however, must be clearly marked with appropriate labels to identify that it is a gas system, the type of the system (low pressure, elevated pressure) and for elevated pressure systems, the system delivery pressure.

The low pressure system can use the label shown in Figure 16.7 while the high pressure system can use markings similar to that shown in Figure 16.8. Labels should be affixed to the tubing on both sides of a wall, floor, or partition, at all changes in direction and at maximum 6' intervals throughout the length of the tube runs. Figure 16.9 shows a typical system label tag. This type of tag can be used for marking valves and other accessory items in the piping system.

Guide to the ANSI A13.1 Standard for the Identification of Pipes		
Material Properties	Typical Applications	Letter Color on Field Color
Inherently Hazardous Materials, Extreme Pressure or Temperature Radioactive Corrosive or Caustic Toxic or Creates Toxic Gas Explosive or Flammable	Fuel Gas, Natural Gas, Liquefied Petroleum, Propane, Butane, Fuel Oil, Boiler Blow Down, Boiler Drain, Boiler Feed Water, Glycol, Condensate, Low Pressure Steam, Non-Potable Water, Vacuum	Black On Yellow

Pipe O.D. Including Covering		Minimum Length of Label Field Color		Minimum Height of Letters	
3/4" to 1-1/4"	19 mm to 32 mm	8"	203 mm	1/2"	13 mm
1-1/2" to 2"	38 mm to 51 mm	8"	203 mm	3/4"	19 mm
2-1/2" to 4"	64 mm to 108 mm	12"	305 mm	1-1/4"	32 mm

Table 16.7 Pipe marking guide

Marker Placement:

- Near valves, flanges and changes in direction.
- At both sides of ceiling, wall, or floor penetrations.
- At any line entry point.
- At frequent intervals on straight runs, typically every 6'.
- Locating pipemarkers so they are visible from the point of normal approach.
- Providing arrows at one or both ends of the label to indicate direction of flow.

Note: This guide is for general information purposes only. Pipe Markings shall be in accordance with project specifications, or in the absence of project specifications, in accordance with local code requirements.



Figure 16.7 Pipe label for low pressure gas



Figure 16.8 Pipe label for high pressure gas

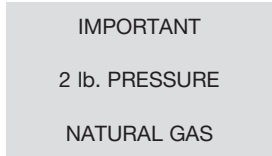
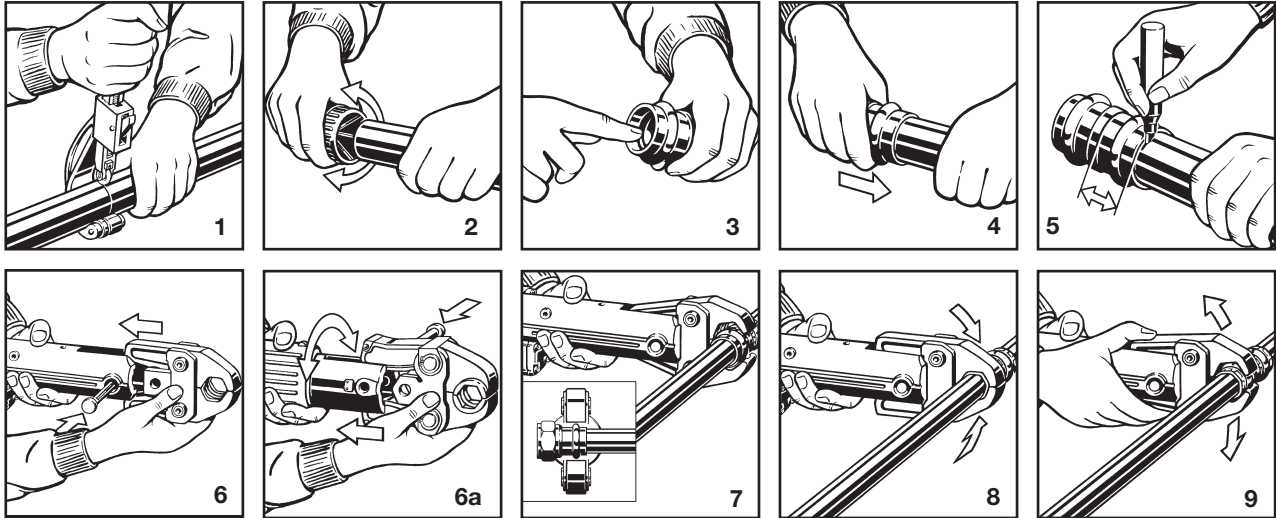

Figure 16.9 Pipe tag for small dimension tubing and system accessories

16.12 Installation Instructions

For Types K or L Hard Copper Tubing in 1/2" to 2" and Soft Copper Tubing in 1/2" to 1-1/4".

⚠ WARNING Read and understand all instructions for installing ProPress fittings. Failure to follow all instructions may result in extensive property damage, serious injury, or death.



1. Cut copper tubing at right angles (using displacement type cutter or fine-toothed steel saw).
2. Deburr tubing on inside and outside to prevent cutting fitting seal.
3. Check seal for correct fit. Do not use oils or lubricants. Use only ProPress Yellow HNBR Elements.
4. While turning slightly, slide press fitting onto tubing to the fitting stop. **Note: End of tubing must contact stop**
5. Mark insertion depth.
6. Insert the appropriate jaw into the pressing tool and push in holding pin until it locks into place.
7. Open the jaw and place at right angles on the fitting. Visually check insertion depth using mark on tubing.
8. Start pressing process and hold the trigger until the jaw has engaged the fitting.
9. After pressing, the jaw can be opened again.



Pressure Testing: Pressure testing is to be carried out in accordance with local codes. The Smart Connect® Feature provides quick and easy identification of unpressed connections during the pressure testing process.

Unpressed connections are located by pressurizing the system with a maximum pressure range of 1/2 – 85 psi for gases and 15 – 85 psi for liquids. The SC Feature is a special indentation in 1/2" to 2" dimensions located on the inside surface of the fitting near the sealing element. This indentation assures leakage of liquids and/or gases from inside the system past the sealing element of an unpressed connection. The indentation is removed during the pressing process creating a leak-free, permanent connection.

⚠ WARNING The following standards, codes and instructions should be followed when installing ProPressG Fittings for fuel gas.

- The installation shall be made in accordance with local codes or in the absence of local codes, in accordance with the National Fuel Gas Code, NFPA 54, the LP- Gas Code NFPA 58, as applicable.
- For use with type K or L copper tubing, drawn copper from 1/2" to 2" and annealed copper from 1/2" to 1-1/4". All copper must be in compliance with ASTM B88
- The fittings are for use with fuel gases only and are intended for operating pressure specified (maximum 125 psi).
- Undue stress or strain on the fittings and the tubing is to be avoided.
- Concealed tubing and fittings shall be protected from puncture threats.
- If the installation requires components in addition to those supplied by the fitting manufacturer, those components shall be specified. The instructions shall state that only the components provided or specified by the manufacturer are to be used in the installation.
- The fitting/tubing system shall not be used as a grounding electrode for an electrical system.
- The inspection, testing and purging of the installation shall be performed using procedures specified in Part 4 of the National Fuel Gas Code, ANSI Z223.1, The LP-Gas Code NFPA 58, section 3.2 – 10 as applicable, or in accordance with the requirements of the applicable local codes.
- For use with natural, propane, mixed and manufactured gases in the vapor state, not in the liquid state.
- The fitting/tubing system shall not be used as a means of support.

17. SYSTEM DESIGN AND SIZING

17.1 System Design

ProPressG fittings and copper tubing may be used in any fuel gas piping systems where the quality of the fuel gas has less than or equal to 0.3 grains of hydrogen sulfide per 100 standard cubic feet of gas (0.7 milligrams per 100 liters). Information regarding fuel gas quality may be obtained from the local gas supplier. For natural gas, contact the local gas utility. For liquid propane gas, contact the liquid propane gas supplier. Viega manufactures a full line of ProPressG fittings ranging from 1/2" to 2". These fittings may be used in fuel gas piping systems, including natural gas and liquid propane gas while using copper tubing.

Fuel gas piping systems are typically very low pressure piping system. The majority of fuel gas piping systems

inside a building have an operating pressure of 0.5 psi or less. Codes limit the maximum pressure of fuel gas piping systems inside the building to 5 psi or less.

Exceptions to this limitation are special piping systems for research, industrial processing, warehouses, boiler and mechanical rooms.

The Viega ProPressG fitting system, using copper tubing, is listed by CSA LC-4 for fuel gas pressures up to 125 psi. ProPressG fittings can be used in virtually every fuel gas piping system inside the building.

ProPressG fittings may be installed above and below ground, both inside and outside of a building. Because copper tubing is a corrosion resistant material, copper tubing may be installed underground with ProPressG

connections also installed underground. Copper tubing may also be installed underground from the source to the building, meter, or regulator.

Using good engineering practices, a ProPressG system can be designed using the smallest allowable size of tubing that will supply gas to the appliance at the required volume and pressure. For a single-family dwelling, the gas company will frequently install the meter outdoors and terminate its facilities with a 1" NPS (Nominal Pipe Size) threaded connection outside the building.

The transition to copper tube can be made at that point. Care should be taken to ensure that the copper tube is not used to support the meter. This can be accomplished by anchoring the meter to the exterior wall. Some gas companies will set the meter with a

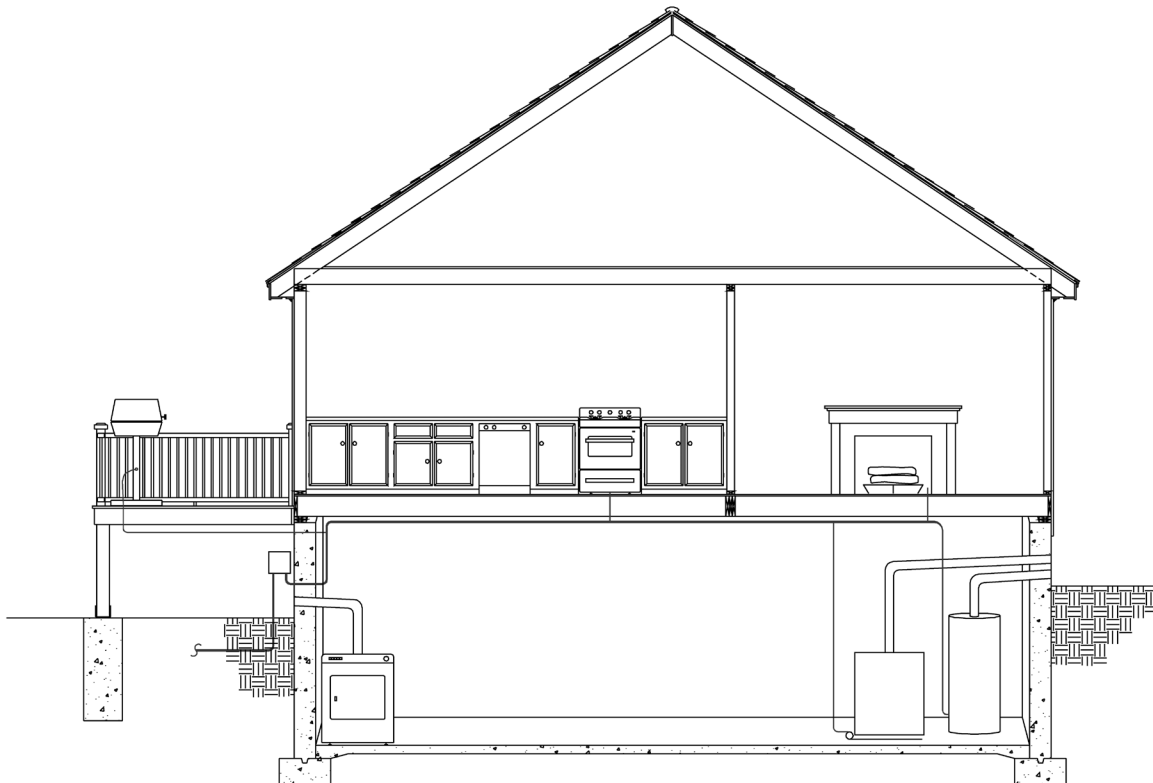

Figure 17.1: Typical Branch Piping

brace or bracket and run copper tube through to the outside allowing service personnel to be aware that it is a semi-rigid system and damage can be avoided.

The connection between the steel system and copper system does not create a corrosion concern if the connection is made in a dry location or a location that does not allow moisture to collect at the connection. The absence of continuous moisture prevents the occurrence of galvanic action and subsequent corrosion of the steel pipe.

There are two basic types of fuel gas piping layouts for residential applications. One method includes a gas main run through the building with branch pipes running from the main to supply gas to the various appliances. The other is a home run system with individual runs to each appliance from a gas distribution manifold installed between the meter and the appliances. Depending on the

building being supplied, a combination of these two systems may also be used.

A low pressure house layout with branch piping is shown in figure 17.1. A low pressure house layout with individual runs is shown in Figure 17.2.

17.2 System Sizing

Fuel gas piping system using copper tubing with ProPressG fittings may be sized using Tables 17.1 through 17.9. The tables are intended to be used when sizing in accordance with the longest length method. The first step in sizing is to determine the appropriate table to use when sizing the fuel gas piping system. Tables 17.1 through 17.7 are sizing tables for natural gas. Tables 17.8 and 17.9 are sizing tables for liquid propane gas.

The headings in the table indicate the inlet gas pressure, the pressure drop and the specific gravity. The gas provider or utility will identify what

gas pressure and pressure drop to use for sizing a fuel gas piping system utilizing their fuel gas.

Once the proper table is selected, the longest length method of sizing is determined by measuring the distance from the point of delivery (gas meter or second stage regulator) to the most remote appliance connection.

This distance will establish the length of the piping system when determining the pipe size.

Reading the values across the row for the length of the piping system indicate the cubic feet per hour of gas that will flow for a given pipe size.

The copper tubing is sized based on the total load of the system for each section of the fuel gas piping system. When a branch piping system is installed, the longest length method of sizing allows the branches to be sized independently of the main runs of piping.

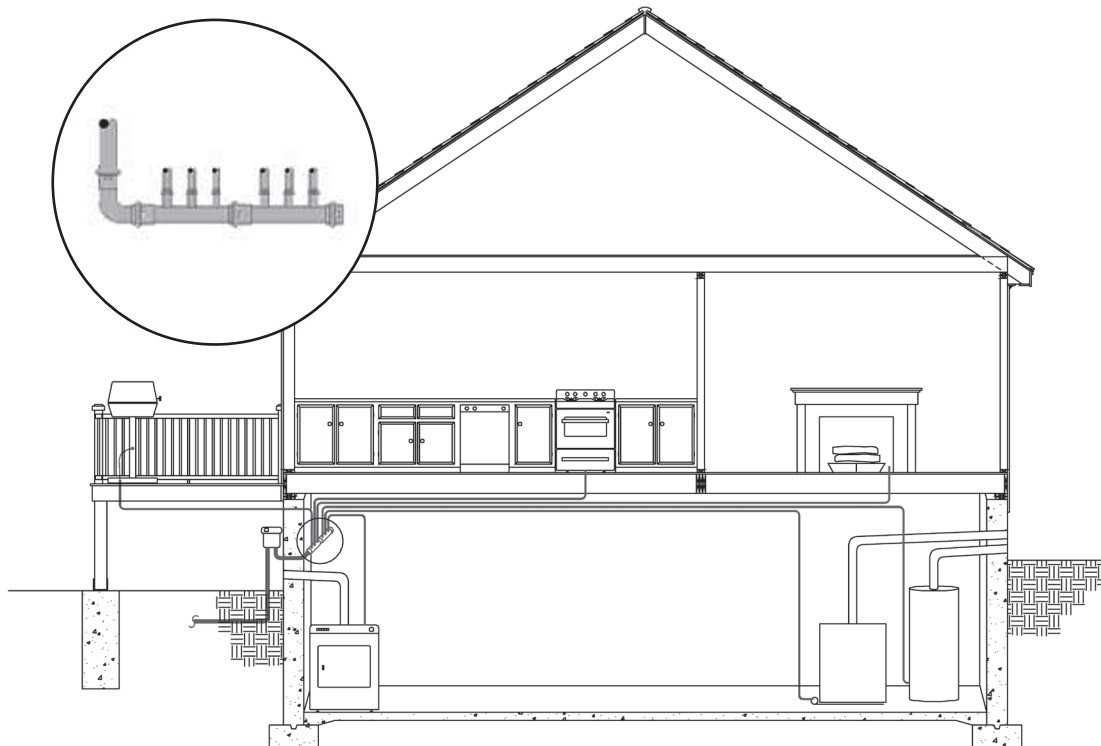

Figure 17.2: Typical manifold and individual runs

The main runs of piping are still sized based on the longest length and total load method. Each branch can then be individually sized.

The length of piping to apply when using the table is the length of piping from the point of delivery to the most remote appliance in the branch including both horizontal and vertical piping.

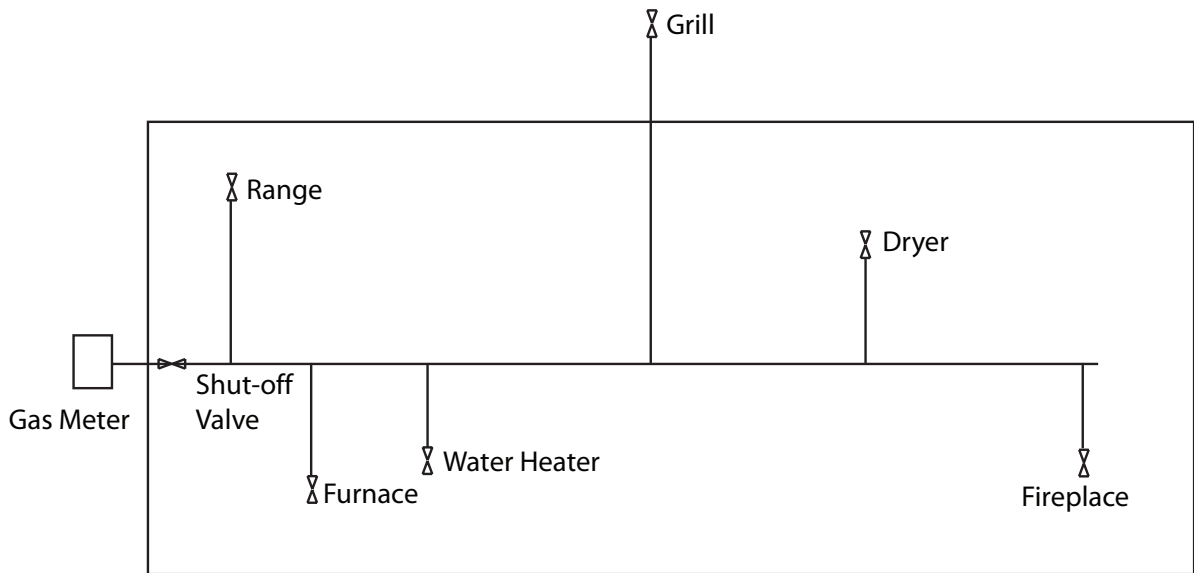

Figure 17.3 Typical residential piping layout with branch runs

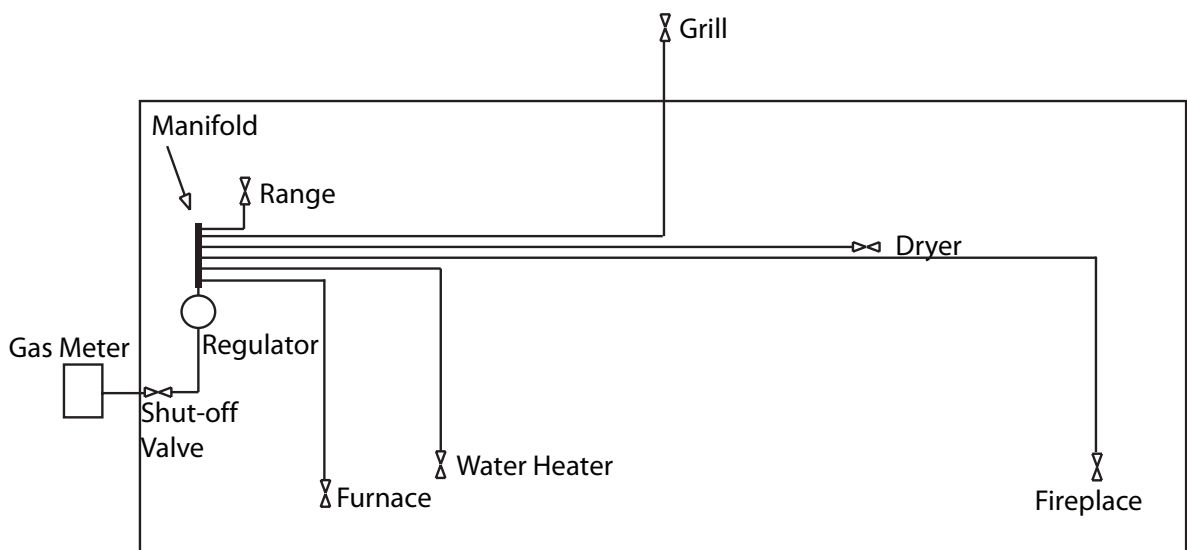

Figure 17.4 Typical residential piping layout with manifold and individual runs.

**Table 17.1
Copper Tubing**

Gas	Natural
Inlet Pressure	0.5 PSI or less
Pressure Drop	0.3 inch WC
Specific Gravity	0.60

		TUBE SIZE (in.)					
Nominal	K & L	1/2	3/4	1	1-1/4	1-1/2	2
Length (ft)		Maximum Capacity in Cubic Feet per Hour					
10		85	210	448	806	1,271	2,646
20		58	144	308	554	873	1,819
30		47	116	247	445	701	1,461
40		40	99	211	381	600	1,250
50		35	88	187	337	532	1,108
60		32	79	170	306	482	1,004
70		29	73	156	281	443	924
80		27	68	145	262	413	859
90		26	64	136	245	387	806
100		24	60	129	232	366	761
125		22	53	114	206	324	675
150		20	48	103	186	294	612
175		18	45	95	171	270	563
200		17	41	89	159	251	523
250		15	37	78	141	223	464
300		13	33	71	128	202	420

**Table 17.2
Copper Tubing**

Gas	Natural
Inlet Pressure	0.5 PSI or less
Pressure Drop	0.5 inch WC
Specific Gravity	0.60

		TUBE SIZE (in.)					
Nominal	K & L	1/2	3/4	1	1-1/4	1-1/2	2
Length (ft)		Maximum Capacity in Cubic Feet per Hour					
10		111	276	590	1,062	1,675	3,489
20		77	190	406	730	1,151	2,398
30		61	152	326	586	925	1,926
40		53	131	279	502	791	1,648
50		47	116	247	445	701	1,460
60		42	105	224	403	635	1,323
70		39	96	206	371	585	1,218
80		36	90	192	345	544	1,133
90		34	84	180	324	510	1,063
100		32	79	170	306	482	1,004
125		28	70	151	271	427	890
150		26	64	136	245	387	806
175		24	59	125	226	356	742
200		22	55	117	210	331	690
250		20	48	103	186	294	612
300		18	44	94	169	266	554

**Table 17.3
Copper Tubing**

Gas	Natural
Inlet Pressure	0.5 PSI or less
Pressure Drop	1.0 inch WC
Specific Gravity	0.60

Table for sizing tubing from house line regulator to the appliance

Nominal	K & L	TUBE SIZE (in.)					
		1/2	3/4	1	1-1/4	1-1/2	2
Length (ft)		Maximum Capacity in Cubic Feet per Hour					
10		162	402	859	1,546	2,437	5,076
20		111	276	590	1,062	1,675	3,489
30		89	222	474	853	1,345	2,802
40		77	190	406	730	1,151	2,398
50		68	168	359	647	1,020	2,125
60		61	152	326	586	925	1,926
70		57	140	300	539	851	1,772
80		53	131	279	502	791	1,648
90		49	122	262	471	742	1,546
100		47	116	247	445	701	1,461
125		41	103	219	394	622	1,295
150		37	93	198	357	563	1,173
175		34	85	183	329	518	1,079
200		32	79	170	306	482	1,004
250		28	70	151	271	427	890
300		26	64	136	245	387	806

**Table 17.4
Copper Tubing**

Gas	Natural
Inlet Pressure	2.0 PSI or less
Pressure Drop	17.0 inch WC
Specific Gravity	0.60

Nominal	K & L	TUBE SIZE (in.)					
		1/2	3/4	1	1-1/4	1-1/2	2
Length (ft)		Maximum Capacity in Cubic Feet per Hour					
10		796	1,974	4,216	7,591	11,968	24,926
20		547	1,357	2,898	5,217	8,226	17,132
30		439	1,089	2,327	4,189	6,605	13,757
40		376	932	1,992	3,586	5,653	11,775
50		333	826	1,765	3,178	5,010	10,436
60		302	749	1,599	2,879	4,540	9,455
70		278	689	1,471	2,649	4,177	8,699
80		258	641	1,369	2,464	3,886	8,093
90		243	601	1,284	2,312	3,646	7,593
100		229	568	1,213	2,184	3,444	7,172
125		203	503	1,075	1,936	3,052	6,357
150		184	456	974	1,754	2,765	5,760
175		169	420	896	1,614	2,544	5,299
200		157	390	834	1,501	2,367	4,930
250		140	346	739	1,330	2,098	4,369
300		126	313	670	1,205	1,901	3,959

Table 17.5
Copper Tubing

Gas	Natural
Inlet Pressure	2.0 PSI or less
Pressure Drop	1.0 inch WC
Specific Gravity	0.60

Nominal	K & L	TUBE SIZE (in.)					
		1/2	3/4	1	1-1/4	1-1/2	2
Length (ft)		Maximum Capacity in Cubic Feet per Hour					
10		1,030	2,554	5,455	9,820	15,483	32,247
20		708	1,755	3,749	6,749	10,641	22,163
30		568	1,409	3,011	5,420	8,545	17,798
40		486	1,206	2,577	4,639	7,314	15,232
50		431	1,069	2,284	4,111	6,482	13,500
60		391	969	2,069	3,725	5,873	12,232
70		359	891	1,904	3,427	5,403	11,253
80		334	829	1,771	3,188	5,027	10,469
90		314	778	1,662	2,991	4,716	9,823
100		296	735	1,570	2,826	4,455	9,279
125		263	651	1,391	2,504	3,948	8,223
150		238	590	1,260	2,269	3,577	7,451
175		219	543	1,160	2,087	3,291	6,855
200		204	505	1,079	1,942	3,062	6,377
250		181	448	956	1,721	2,714	5,652
300		164	406	866	1,559	2,459	5,121

Table 17.6
Copper Tubing

Gas	Natural
Inlet Pressure	2.0 PSI or less
Pressure Drop	1.5 PSI
Specific Gravity	0.60

Nominal	K & L	TUBE SIZE (in.)					
		1/2	3/4	1	1-1/4	1-1/2	2
Length (ft)		Maximum Capacity in Cubic Feet per Hour					
10		1,272	3,155	6,739	12,131	19,127	39,837
20		874	2,168	4,631	8,338	13,146	27,380
30		702	1,741	3,719	6,696	10,557	21,987
40		601	1,490	3,183	5,731	9,035	18,818
50		533	1,321	2,821	5,079	8,008	16,678
60		483	1,197	2,556	4,602	7,256	15,112
70		444	1,101	2,352	4,234	6,675	13,903
80		413	1,024	2,188	3,939	6,210	12,934
90		388	961	2,053	3,695	5,826	12,135
100		366	908	1,939	3,491	5,504	11,463
125		324	804	1,718	3,094	4,878	10,159
150		294	729	1,557	2,803	4,420	9,205
175		270	671	1,432	2,579	4,066	8,469
200		252	624	1,333	2,399	3,783	7,878
250		223	553	1,181	2,126	3,352	6,982
300		202	501	1,070	1,927	3,038	6,327

Pipe sizing between point of delivery and the house line regulator. Total load supplied by a single house line regulator not exceeding 150 cubic feet per hour

**Table 17.7
Copper Tubing**

Gas	Natural
Inlet Pressure	5.0 PSI or less
Pressure Drop	3.5 PSI
Specific Gravity	0.60

		TUBE SIZE (in.)					
Nominal	K & L	1/2	3/4	1	1-1/4	1-1/2	2
Length (ft)		Maximum Capacity in Cubic Feet per Hour					
10		2,144	5,315	11,354	20,441	32,229	67,125
20		1,473	3,653	7,804	14,049	22,151	46,135
30		1,183	2,934	6,267	11,282	17,788	37,048
40		1,013	2,511	5,364	9,656	15,224	31,708
50		898	2,225	4,754	8,558	13,493	28,102
60		813	2,016	4,307	7,754	12,225	25,463
70		748	1,855	3,962	7,134	11,247	23,425
80		696	1,726	3,686	6,636	10,463	21,793
90		653	1,619	3,459	6,227	9,817	20,447
100		617	1,529	3,267	5,882	9,273	19,315
125		547	1,356	2,896	5,213	8,219	17,118
150		495	1,228	2,624	4,723	7,447	15,510
175		456	1,130	2,414	4,345	6,851	14,269
200		424	1,051	2,245	4,042	6,374	13,725
250		376	932	1,990	3,583	5,649	11,765
300		340	844	1,803	3,246	5,118	10,660

**Table 17.8
Copper Tubing**

Gas	Undiluted Propane
Inlet Pressure	11.0 inch WC
Pressure Drop	0.5 inch WC
Specific Gravity	1.50

Sizing between single or second stage (low pressure regulator) and appliance

		TUBE SIZE (in.)					
Nominal	K & L	1/2	3/4	1	1-1/4	1-1/2	2
Length (ft)		Maximum Capacity in Cubic Feet per Hour					
10		188	467	997	1,795	2,830	5,895
20		129	321	685	1,234	1,945	4,051
30		104	258	550	991	1,562	3,253
40		89	220	471	848	1,337	2,784
50		79	195	417	752	1,185	2,468
60		71	177	378	681	1,074	2,236
70		66	163	348	626	988	2,057
80		61	152	324	583	919	1,914
90		57	142	304	547	862	1,796
100		54	134	287	517	814	1,696
125		48	119	254	458	722	1,503
150		44	108	230	415	654	1,362
175		40	99	212	382	602	1,253
200		37	92	197	355	560	1,166
225		35	87	185	333	525	1,094
250		33	82	175	315	496	1,033
275		31	78	166	299	471	981
300		30	74	158	285	449	936

**Table 17.9
Copper Tubing**

Gas	Undiluted Propane
Inlet Pressure	10 PSI
Pressure Drop	1.0 PSI
Specific Gravity	1.50

Sizing between first stage (high pressure regulator) and second stage (low pressure regulator)

		TUBE SIZE (in.)					
Nominal	K & L	1/2	3/4	1	1-1/4	1-1/2	2
Length (ft)		Maximum Capacity in Cubic Feet per Hour					
10		2,152	5,335	11,396	20,516	32,347	67,371
20		1,479	3,667	7,832	14,101	22,232	46,303
30		1,188	2,944	6,290	11,323	17,853	37,183
40		1,016	2,520	5,383	9,691	15,280	31,824
50		901	2,234	4,771	8,589	13,542	28,205
60		816	2,024	4,323	7,782	12,270	25,556
70		751	1,862	3,977	7,160	11,288	23,511
80		699	1,732	3,700	6,661	10,502	21,873
90		655	1,625	3,471	6,250	9,853	20,522
100		619	1,535	3,279	5,903	9,307	19,385
125		549	1,361	2,906	5,232	8,249	17,181
150		497	1,233	2,633	4,741	7,474	15,567
175		457	1,134	2,423	4,361	6,876	14,321
200		426	1,055	2,254	4,057	6,397	13,323
225		399	990	2,115	3,807	6,002	12,501
250		377	935	1,997	3,596	5,669	11,808
275		358	888	1,897	3,415	5,385	11,215
300		342	847	1,810	3,258	5,137	10,699

Professional products, service, and training for professional contractors

viega

Rely on Viega for the most complete line of high-tech/
high-quality plumbing, heating and snow melting systems
available today ... plus the most comprehensive customer
field support in the industry.

Dedicated to education, Viega has been recognized
by industry professionals as offering some of the most
innovative, informative and interactive training courses.
We have a comprehensive list of sessions in a variety
of forms from half-day workshops to rigorous three-day
programs. Call to receive our complete course catalog.



Viega

301 N. Main, 9th Floor, Wichita, KS 67202
Phone: 1-800-976-9819 Fax: 1-800-976-9817
www.viega.com • service@viega.com

Viega IM-MTL 0309

ProPress® System

Flameless
copper joining
technology.



ProPressG™ Systems

Flameless
copper fuel
gas joining
technology.

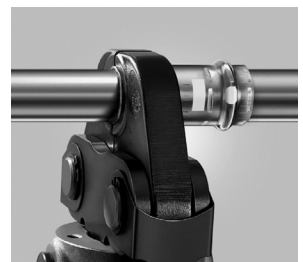

PureFlow® Systems

Flexible
PEX tubing
plumbing
technology.

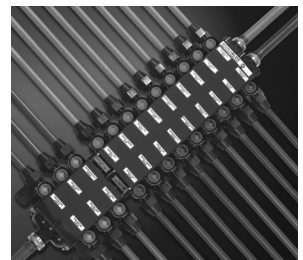

PureFlow® Stainless Systems

Flameless
stainless steel
joining
technology.



ProPress® Marine Systems

Flameless joining
technology for
shipbuilding.



ProRadiant Systems

Comfortable,
efficient heating
technology.

